

Operator's Guide
ELITEpro™ XC

and

ELOG™ 19

Software



ELITEpro XC™/ELOG™ 19
May 27, 2019

Operator's Guide: ELITEpro XC and ELOG™ Software ©2019 DENT Instruments, Inc. All rights reserved.
This manual may not be reproduced or distributed without written permission from DENT Instruments.

Congratulations!

You now own one of the world's most versatile, accurate, feature-rich, and lowest priced power/energy loggers, the ELITEpro XC™. The ELITEpro XC logger contains many features, some of which enable you to measure data across multiple platforms, view and graph real-time data, and retrieve data remotely.

In addition, this manual describes the features and functionality of the accompanying ELOG™ **Software**, which is designed to be user-friendly, intuitive, and an easy-to-use component of your energy measuring projects.

Thank You for your business!

Trademarks

ELITEpro XC™, ELOG™, and PhaseChek™ are trademarks of DENT Instruments, Inc.

Windows®, Windows® 7, Windows® 8, Windows® 10, and Notepad® are registered trademarks of Microsoft Corporation.

Bluetooth® wireless technology is a registered trademark of the *Bluetooth* SIG. If your unit is equipped with *Bluetooth* wireless technology, look for the following trademark symbol: 

DENT Instruments | 925 SW Emkay Drive | Bend, Oregon 97702 USA
Phone 541.388.4774 | Fax 541.385.9333 | www.DENTinstruments.com

TABLE OF CONTENTS

Congratulations!	ii
Trademarks	ii
Table of Contents	iii
Introduction	7
ELITEpro XC SAFETY SUMMARY and SPECIFICATIONS	8
ELITEpro XC RÉSUMÉ DE SÉCURITÉ ET SPÉCIFICATIONS	12
ELITEpro XC CONNECTIONS	15
Quick Start to Using the ELITEpro	16
Install the ELOG Software on the Computer	16
Mount the ELITEpro XC	17
ELITEpro XC Connections	18
Complete the Wiring Connections	19
CT Connections	19
Connecting Split-Core Style Millivolt CTs to a Load	20
Connecting RōCoil CTs to a Load	22
Voltage Connections	23
Analog Channel Connections	23
Current Loop Connection	24
Voltage Connection	25
Power In/Out Connection	27
Digital Channel Connections	27
Connecting the USB Cable	29
Other Communication Connections	30
Communicating with the ELITEpro XC	31
Terminating the ELITEpro XC to Computer Connection	33
In depth Use of the ELITEpro XC and ELOG	34
Creating and Using the Logger Setup Tables	34
Create a New Setup Table	34
Open an Existing Setup Table on Your PC	35
Retrieve an Existing Setup Table from the ELITEpro XC	36
Configure the Setup Table	37
Data Logging Controls	38
Start Options	38
Stop Options	38
Memory Capacity	38
Quick Setups	39
Physical Power Channels	41

Calculated Power Channels	45
Combining Channels	45
Analog Output Channels (ELITEpro XC Only).....	46
Send a Setup Table to the Logger.....	47
Save a Setup Table on the Computer	48
LED Diagnostics	48
PhaseChek™ LEDs.....	48
COMM—Communications LED	49
Power Measurement—Connecting Sensors & Configuring Channels.....	50
Wiring Label Conventions.....	51
Current Transformer (CT) Selection	51
CT Selection Examples.....	53
Connecting CTs and Configuring Channels.....	53
ELOG Quick Setup Wiring Diagrams	55
Using the ELOG Software	59
ELOG Speed Buttons.....	59
File Menu.....	61
Edit Menu	63
View Menu	63
Logger Menu	64
Communication Sub-Menu.....	64
Retrieve Data From Logger	69
Display Real-Time Values Sub-Menu	71
Retrieve Logger Setup Table	77
Logger Clock Sub-Menu	77
Edit Logger Description Line	78
Logging ON/OFF	78
Clear Logger Sub-Menu.....	79
Tools Menu.....	80
PC Setup.....	80
Update ELITEpro XC Firmware	81
Restore Hidden Messages.....	81
Data Menu.....	82
Create New Graph	82
Graph Options.....	85
Retrieve Data From Logger	86
Open Data File	86
Export Data File.....	86
Import CSV File.....	87
Data File Statistics.....	88

- Analyze a Selected Data Range 90
- Extract a Range of Data..... 91
- Check Data for Errors..... 92
- Fill Missing Records with Zeros..... 92
- Fill missing Records with Blanks 92

- Appendices 93**
 - Appendix A—Installing Firmware Updates..... 93
 - Firmware Updates 93
 - Downloading and Installing Firmware 93
 - Appendix B—Unusual Metering Systems 94
 - 3-Phase Delta with a “Wild” (Red) Leg..... 94
 - 2-½ Element Meters 95
 - Using The 2-Watt Element (2 Ct) Method On A 3-Wire Delta Service 96
 - Using The 3-Watt Element (3 Ct) Method On A 3-Wire Delta Service 97
 - Appendix C—Troubleshooting ELITEpro XC Driver Installation 99
 - Appendix D—Calculated Power Channel Formulas 102
 - Wye Configuration L1-N, L2-N, L3-N 102
 - DELTA Configuration: L1-L2 and L3-L2 103
 - Appendix E—Communication Options on the ELITEpro XC..... 104
 - USB (Standard) 104
 - Ethernet LAN (Standard) 105
 - Wi-Fi and Wireless Access Point-to-Point Connection (Optional) 108
 - ELITEpro XC as its own Access Point 109
 - ELITEpro XC Connected to a Wireless Network 110
 - Accessing the ELITEpro 113
 - Troubleshooting Wi-Fi Connections 115
 - Bluetooth (Optional)..... 116
 - Appendix F—Meter Installation Final Checklist..... 119
 - Appendix G – ELITEpro XC Technical Specifications 122
 - Appendix H – DENT Instruments Warranty Statement 124

- Index 126**

INTRODUCTION

The ELITEpro XC is a powerful and versatile tool for pinpointing electric usage and quantifying energy usage. It is capable of measuring, storing, and analyzing consumption data including Volts, Amps, Watts, Volt-Amps (VA), Volt-Amps reactive (VAR), Kilowatts (kW), Kilowatt Hours (kWh), KVAh, kVARh, and Power Factor (PF) of an electrical load or an entire building. Analog input channels are especially helpful when used in conjunction with power measurements to correlate the consumption of electricity with environmental, HVAC plant performance or other process conditions. The ELITEpro XC also offers some power quality features such as the ability to view in real-time voltage, current, and power waveforms and calculate harmonics to the 63rd order.

The ELITEpro XC is line-powered from the service being measured, eliminating the need for external power or space-consuming batteries at the job site. The measurements are stored in on-board, non-volatile memory in a time series format at an interval selected by the user. The ELITEpro XC can be mounted anywhere with its magnetic mounting feet and is small enough to be secured inside the electrical panel.

The Windows-based ELOG software package is used to set up the meter, display metered values, and retrieve and analyze the collected data. ELOG graphically displays recorded data, performs analysis and facilitates automatic remote data collection. Data is also easily exported to popular spreadsheet and database programs for additional analysis.



The ELITEpro XC requires a computer and ELOG™ software for setup, data retrieval, and data analysis. Download and test the software prior to the field installation of the logger.

If your installation is using ELOG with legacy devices, contact DENT Instruments for a prior version of this manual.

For further information, or to provide comments and suggestions, contact us at:

800.388.0770 or support@DENTInstruments.com

ELITEpro XC SAFETY SUMMARY and SPECIFICATIONS

<p>This general safety information is to be used by both the Logger operator and servicing personnel. DENT Instruments, Inc. assumes no liability for user's failure to comply with these safety guidelines.</p>	  4RH8 E186827	<p>Conforms to UL Std 61010-1 Certified to CSA Std C22.2 No. 61010-1</p>
<p>The ELITEpro XC is an Over-Voltage Category III device. Use approved rubber gloves with mechanical protection and goggles when operating the device.</p>		
<p>CAUTION: This LOGGER may contain life-threatening voltages. QUALIFIED PERSONNEL MUST disconnect all high voltage wiring before using or servicing the LOGGER.</p>		



Warning: Use of this device in a manner for which it is not intended may impair its means of protection.

SYMBOLS ON EQUIPMENT



Denotes caution. See manual for a description of the meanings.

When connecting the ELITEpro XC to an AC load, follow these steps in sequence to prevent a shock hazard.



1. If possible, de-energize the circuit to be monitored.
2. Connect the CTs to the phases being monitored.
3. Connect the voltage leads to the different phases. Use proper safety equipment (gloves, mask, and protective clothing) as required for the voltages monitored.



Risk of electric shock. Life-threatening voltages may be present. Qualified personnel only.



DO NOT EXCEED 600V Phase to Phase. This logger is equipped to monitor loads up to 600V. Exceeding this voltage will cause damage to the logger and danger to the user. Always use a Potential Transformer (PT) for loads in excess of 600V. The ELITEpro XC is a 600 volt Over-Voltage Category III device.



Dispose of properly.

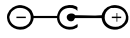

IN: 6-10 VDC, 500 mA

OUT: 6 VDC, 200 mA maximum



USB port

SENSOR LIMITATIONS

USE ONLY SHUNTED CURRENT TRANSFORMERS (CTs).

Do not use other CTs. Only use shunted CTs with a 333mV maximum output only. Serious shock hazard and logger damage can occur if unshunted CTs are used. The UL listing covers the use of the following DENT Instruments CTs that are UL Recognized and have been evaluated to IEC 61010-1:



CT-RGT12-XXXX (solid core), CT-SRS-XXX (split core), CT-HSC-020-X (20A Mini), CT-HSC-050-X (50A Mini), CT-HMC-0100-X (100A Midi), CT-HMC-0200-X (200A Midi), CT-RXX-1310-U (RōCoil), CTRXX-A4-U (RōCoil), CT-CON-1000-X, CT-CON-0150EZ-X and the CT-SRL-XXX or CT's that are UL listed to UL2808.

The use of any other CT will invalidate the UL Listing of the ELITEpro XC.



Pulse: Use only "dry contact" non-energized pulse inputs (ELITEpro SP only).

Use of energized pulse initiators can cause damage to the logger and a potential shock hazard to the user. Wiring must meet 600V AC CAT III rating.

DC VOLTAGES

The meter is designed to measure AC voltages for installations up to 600 VAC. The meter is also capable of measuring DC voltages up to 600 VDC with the following caveats.



1) The internal fuse installed in meters with serial numbers before XC1703xxx are not a suitable disconnect for voltages above 80 VDC. Customers using the meter for high voltage DC systems must install a UL listed inline 600 volt DC fuse with a rating of 1 amp or less. These fuses are commonly available in the solar power market.

2) UL testing of the meter was conducted on AC systems only. DC results are comparable but not tested.

3) DENT Instruments ELOG software does not currently have a configuration that is specific to DC systems. Values reported for voltage, current, KW, KWH will be

correct however it should be noted that the meter will also report values that pertain to AC systems (such as VARs and Power Factor) that should be ignored.



The equipment is protected throughout by double insulation (IEC 536 Class II).
CAT III 80-600 VAC 125mA 50/60 Hz

FCC COMPLIANCE

This device has been tested and found to comply with the limits for a Class A digital device, pursuant to part 15 of the FCC Rules. These limits are designed to provide reasonable protection against harmful interference when the equipment is operated in a commercial environment. This equipment generates, uses, and can radiate radio frequency energy and, if not installed and used in accordance with the instruction manual, may cause harmful interference to radio communications. Operation of this equipment in a residential area is likely to cause harmful interference in which case the user will be required to correct the interference at user's own expense.

Operation is subject to the following two conditions: (1) This device may not cause harmful interference, and (2) this device must accept any interference received, including interference that may cause undesired operation.

MAINTENANCE

There is no required maintenance with the ELITEpro XC. Abide by the following items:

Cleaning: No cleaning agents, including water, shall be used on the ELITEpro XC.



Battery Life: The lithium battery is only used to maintain the date and clock settings during power failure and has a life expectancy of greater than 10 years. Contact DENT Instruments for service.

No accessories are approved for use with the ELITEpro XC other than those specified in the DENT Instruments product literature and price sheets.

If the logger appears damaged or defective, first disconnect all power and sensors. Call or email technical support for assistance.

DENT Instruments
Bend, Oregon USA
Phone: 541.388.4774
www.DENTinstruments.com
Email: support@DENTinstruments.com

ELITEpro XC RÉSUMÉ DE SÉCURITÉ ET SPÉCIFICATIONS

<p>Cette information de sécurité est destinée à être utilisée à la fois par l'opérateur de l'enregistreur et le personnel de service. DENT Instruments, Inc n'assume aucune responsabilité pour l'utilisateur qui ne respecte pas les directives en matière de sécurité.</p>	  4RH8 E186827	<p>Conforme à UL Std 61010-1 Certifié CSA Std C22.2 No. 61010-1</p>
<p>Le ELITEpro XC est un appareil de surtension de catégorie III. Utiliser des gants en caoutchouc approuvé avec protection mécanique et des lunettes lors de l'utilisation de l'appareil.</p>		
<p>ATTENTION: Ce LOGGER peut contenir de hautes tensions qui peuvent être dangereuses. UN PERSONNEL QUALIFIÉ DOIT débrancher tous les câbles à haute tension avant d'utiliser ou de réparer du LOGGER.</p>		



Attention: L'utilisation de cet appareil d'une manière pour laquelle il n'est pas destiné peut annuler ses moyens de protection.

SYMBOLES DES EQUIPEMENTS



Signifie prudence. Voir le manuel pour une description de la signification.

En faisant la connexion du ELITEpro XC à une prise de courant alternatif, suivez ces étapes en ordre pour empêcher un risque de choc.

1. Décharger le circuit à contrôler.



2. Connectez le TC aux phases à surveiller.

3. Connectez les fils de tension à des phases différentes. Utiliser des équipements de sécurité (gants et des vêtements de protection) qui sont nécessaires pour les tensions surveillées.



Indique haute tension. Risque de choc électrique. Hautes tensions peuvent être présentes qui mettent la vie en danger. Personnel qualifié uniquement.

NE PAS DEPASSER 600V Phase à Phase. Ce compteur peut contrôler les charges jusqu'à 600V. Le dépassement de cette tension peut causer des dommages à l'appareil et du danger pour l'utilisateur. Utiliser toujours le potentiel transformateur (PT) pour des charges de plus de 600V. Le ELITEpro XC est un appareil à 600 V de surtension de catégorie III.





Se débarrasser de correctement.

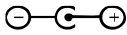

IN: 6-10 VDC, 500 mA

OUT: 6 VDC, 200 mA maximum



USB port

LIMITATIONS DE DÉTECTEUR

UTILISEZ SEULEMENT TRANSFORMATEURS DE COURANT (TC) SHUNTÉE.



N'utilisez pas d'autres TC. Utilisez seulement des TC shuntée avec une puissance maximale 333mV. Un sérieux risque de décharge électrique et des dommages à l'enregistreur peut se produire si des TC pas shuntée sont utilisés. Utiliser seulement les CTs des DENT Instruments suivants qui sont énumérés jusqu'au 600V/CATIII.

CT-RGT12-XXXX (solid core), CT-SRS-XXX (split core), CT-HSC-020-X (20A Mini), CT-HSC-050-X (50A Mini), CT-HMC-0100-X (100A Midi), CT-HMC-0200-X (200A Midi), CT-RXX-1310-U (RöCoil), CTRXX-A4-U (RöCoil), CT-CON-1000-X, CT-CON-0150EZ-X et le CT-SRL-XXX.



Impulsion: n'utilisez que "contact sec" impulsion intrants non charger (ELITEpro SP uniquement). Utilisation de impulsion initiateurs charger peut causer des dommages à l'enregistreur et une décharge électrique potentielle pour l'utilisateur. Il faut que l'installation électrique satisfasse l'évaluation de 600V AC CATIII.



TENSIONS C. C.

La ELITEpro est conçu pour mesurer tensions c. a. pour les installations jusqu'à 600 V c. a. Le ELITEpro est également capable de mesurer les tensions c. c. jusqu'à 600 V c. c. avec les avertissements suivants.

- 1) Le fusible interne installé dans le ELITEpro n'est pas un dispositif de désaccouplage adéquat pour des tensions supérieures à 80 V c. c. Les clients utilisant la ELITEpro pour haute tension DC systèmes doivent installer un UL inline 600 volts DC fusible avec une valeur nominale de 1 amp ou moins. Ces fusibles sont couramment disponibles dans le marché des piles solaires. Serial #'s < XC1703xxx.
- 2) UL tests du ELITEpro a été menée sur systèmes CA uniquement. DC résultats sont comparables, mais pas testé.
- 3) Impact Instruments logiciel ELOG ne dispose actuellement pas de configuration qui sont spécifiques aux systèmes à courant continu. Les valeurs rapportées pour la tension, le courant, en KW, KWH sera correct mais il convient néanmoins de noter que le compteur sera également rapport valeurs qui se rapportent aux systèmes à courant alternatif (tels que VARs et facteur de puissance) qui doit être ignoré.



L'équipement protégé en double isolation (IEC 536 Classe II). CAT III 80-600 VAC 125mA
50/60 Hz

Entretien

Il n'y a aucun entretien requis avec le ELITEpro XC. Respectez les points suivants:

Nettoyage: Aucun agents de nettoyage, y compris l'eau, doit être utilisé sur le ELITEpro XC.

Espérance de Vie de la Batterie: La pile au lithium est utilisée uniquement pour maintenir les paramètres de date et d'heure en cas de coupure de le courant et a une espérance de vie de plus de 10 ans. Contactez DENT Instruments pour le service.

Pas d'accessoires approuvés pour une utilisation avec le ELITEpro XC sauf ceux spécifiés par DENT Instruments dans ses documentations sur les produits et également sur les prix.

Si le compteur semble endommagé ou défectueux, tout d'abord déconnecter le pouvoir de l'appareil. Alors s'il vous plaît appelez 541.388.4774 ou contacter par courriel l'assistance technique pour obtenir de l'aide.

DENT Instruments
Bend, Oregon USA
Phone: 541.388.4774
www.DENTinstruments.com
Email: support@DENTinstruments.com

ELITEpro XC CONNECTIONS

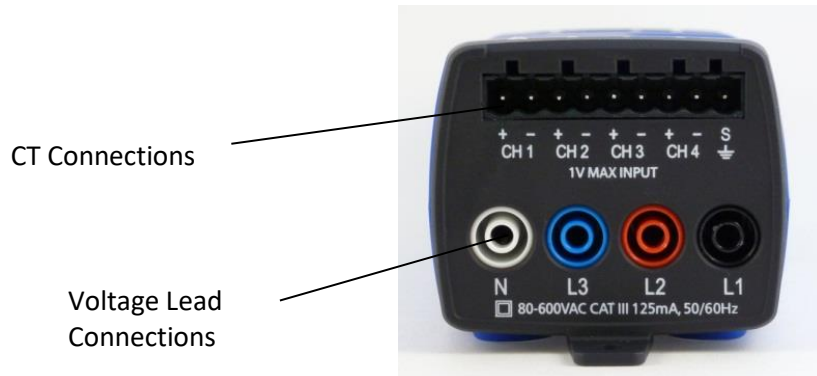
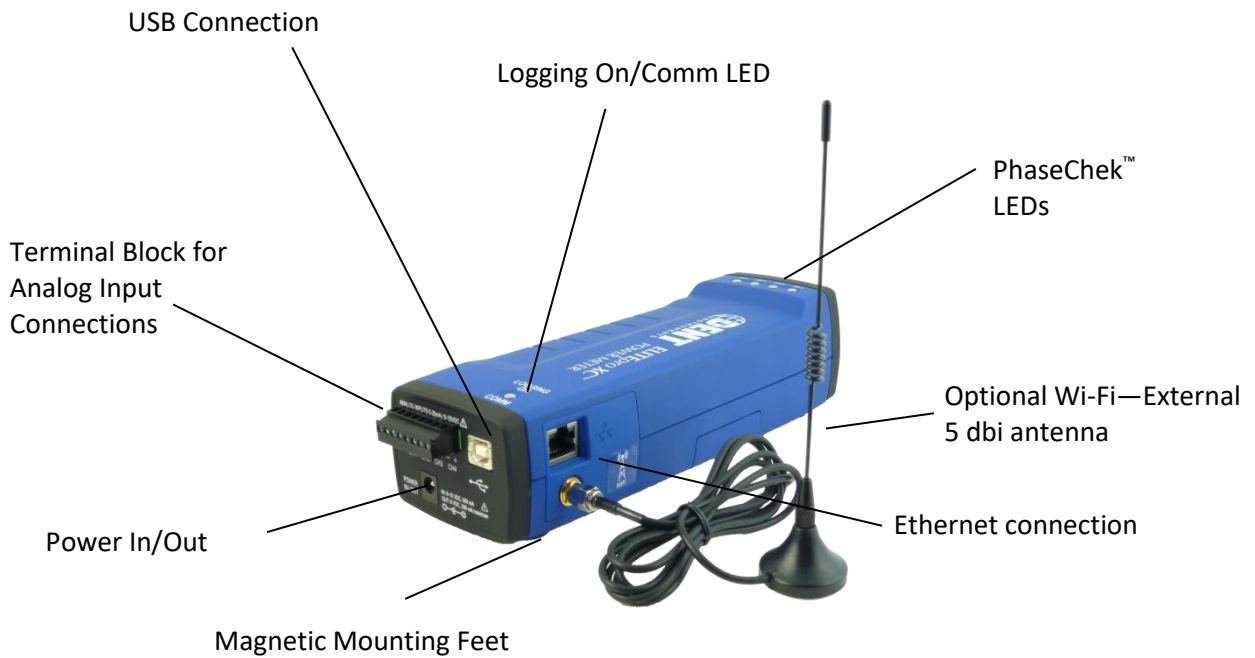

ELITEpro XC Top End View

QUICK START TO USING THE ELITEPRO

IMPORTANT: DO NOT CONNECT THE ELITE^{pro} XC TO YOUR COMPUTER UNTIL YOU HAVE INSTALLED ELOG

Install the ELOG Software on the Computer

Complete this step prior to installation and ascertain that communication between the ELITE^{pro} XC and PC is established before going into the field.

NOTE: The new path for Data files in ELOG is: C:\Users\UserName\Documents\DENT\ELOG\Data

ELOG is compatible with Windows[®] 7, Windows[®] 8, or Windows[®] 10.

- 1) Insert the ELOG USB memory stick into the USB port. Browse to the memory stick and locate the ELOGInstaller.exe file. Start the installer by double-clicking **ELOGInstaller.exe**.
- 2) Follow the directions on the screen to install the software.

NOTE: When ELOG is installed, another program, AutoPoll, is also installed. AutoPoll may be used for unattended and automatic data retrieval from a number of remote loggers where the computer calls the loggers. See *Appendix D—AUTOPOLL: Unattended Calling from the PC to the Logger*.



- 3) Install the ELITE^{pro} XC Driver on your computer.
 - a) Connect the USB cable to a USB port on your computer, inserting the other end in the USB port on the ELITE^{pro} XC

NOTE: If a USB cable is used inside an electrical panel it must be rated to the appropriate voltage or wrapped in an appropriately rated insulating sleeve. The DENT-supplied cable does not meet this requirement without an insulating sleeve.

- b) Perform the setup steps onscreen. You must allow ELOG to install the USB driver for the ELITE^{pro} XC to work correctly.
- c) If the driver installation fails, see Appendix: Troubleshooting ELITE^{pro} XC Driver Installation.

Mount the ELITEpro XC

The ELITEpro XC must be installed in an approved electrical panel or enclosure, following proper installation practices according to the local electrical codes.

	WARNING! Remove the LOGGER from all sources of voltage before mounting.
	AVERTISSEMENT! ENLEVEZ L'ENREGISTREUR DE TOUTES LES SOURCES DE TENSION AVANT DE MONTER.

- 1) Mount the ELITEpro XC using the black tab on the end of the case. Use a screw to securely mount the ELITEpro XC near a dedicated circuit disconnect breaker.

NOTE: Allow adequate space for accessing all ports and connectors. The mounting tab is intended for short term metering (less than 6 months) and must be subject to monthly monitoring by qualified personnel to verify the ELITEpro XC or its wiring have not shifted.

To remove the logger, remove the screw and roll the magnets off the cabinet to which it is mounted. In order to prevent injury upon removal, it is recommended practice to roll the device off, due to the strength of the magnets.

NOTE: For temporary, spot load monitoring, the four magnets on the back of the ELITEpro XC case can be utilized to hold the logger on unpainted metal. The maximum combined weight of the logger and any attachments the magnets can support with a 4 times safety margin is 18oz (500 gm). The logger must be attended by the electrician when it is temporarily mounted by the four magnets.



2) Mark the dedicated circuit as the disconnect for the ELITEpro XC.

ELITEPRO XC CONNECTIONS

The ELITEpro XC has the following connections:

- Four current transformers (CTs).
- Four voltage wire leads for connecting to voltage sources (L1, L2, L3, and Neutral).
- Four analog input channels can be individually used to record process or environmental correlation studies with power.
- Power In/Out for connecting a DENT-provided external power supply or for powering external devices. Maintain polarity as marked on the case:

In: 6-10 Vdc, maximum input of 500 mA

Out: 6 Vdc output, up to 200 mA for powering other external devices



- USB connector for downloads, setup, and communication with a computer. The ELITEpro XC is also powered from the USB connection. If a USB cable is to be used inside an electrical panel, it must be rated to the appropriate voltage or wrapped in an appropriately rated insulating sleeve. The DENT-supplied cable does not meet this requirement without an insulating sleeve.
- Ethernet port for connecting the device to a network.
- An external coaxial connector for a Wi-Fi antenna may also be present.



It is often easier to connect the CTs and voltage leads to the load to be monitored first then simply plug the voltage leads and CT connectors into the ELITEpro XC before mounting.

Complete the Wiring Connections

The following connections must be completed to install the ELITEpro XC. ALL WORK SHOULD BE PERFORMED BY A QUALIFIED ELECTRICIAN USING PROPER SAFETY EQUIPMENT.

	CAUTION: The ELITEpro XC should only be wired by qualified personnel. Hazardous voltages exist.
	ATTENTION: LE ELITEpro XC ne doit être branché QUE par un personnel qualifié. TENSIONS DANGEREUSES sont présentes.

CT CONNECTIONS

NOTE: Use only inherently safe 333mV output CTs supplied by DENT. Never use current output CTs. The UL listing covers the use of the following DENT Instruments CTs that are UL Recognized and have been evaluated to IEC 61010-1:

CT-HSC-020-X (20A Mini), CT-HSC-050-X (50A Mini), CT-HMC-0100-X (100A Midi), CT-HMC-0200-X (200A Midi), and CTs that are UL listed to UL2808. The use of any other CT will invalidate the UL Listing of the ELITEpro XC.

- 1) Connect the CTs to the channel(s) on the ELITEpro XC labeled CH 1, CH 2, CH 3 and CH 4. The CT leads need to be connected to the terminal block using a small screwdriver. For RōCoils, also connect the shield (bare) wires to the right-most ground terminal marked “S” (shield).
- 2) Place the CTs on the phase wires of the load to be monitored and corresponding to the phase of the voltage loads. The CTs must be placed as follows for each channel:
 - Left connector pin is the positive or high-side wire
 - Right pin is the negative or low-side

When using DENT Instruments current transformers, connect them as follows:

- Split-core CTs (removable leg)—the white CT wire is (+) and the black wire is (-).
- Clamp-on CTs (clothes-pin type)—the red wire is positive (+) and the black wire is negative (-).
- RōCoil CTs (flexible, Rogowski-style)—the white CT wire is (+) and the brown wire is (-).

If you are using RōCoil CTs, be sure to connect the bare wire to the “S” (shield) screw terminal. This reduces interference and improves the accuracy of the CT.

Connecting Split-Core Style Millivolt CTs to a Load

- 1) Open the CT by holding on to the removable leg and pulling it apart.



- 2) Connect CT around the load conductor to be measured. Make sure the maximum current of the conductor does not exceed the maximum CT rating listed on the CT data sheet.

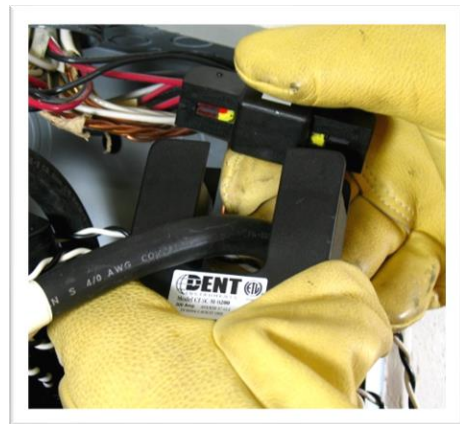

- 3) Carefully re-connect the removable leg while ensuring the CT core alignment matches. The conductor should be in the inside of the CT window.

Repeat Steps 1-3 if you are using more than one CT.

- 4) Connect the **white wire** on the CT to the **positive terminal** on the measuring device.
- 5) Connect the **black wire** on the CT to the **negative terminal** on the measuring device.



CT 1 must be placed on the phase listed as V High for Channel 1 in the ELOG setup table. CT2, CT3 and CT4 must also correspond to the appropriate phase as shown in Channels 2, 3, and 4 in the ELOG setup table.



Correct orientation of a CT is required to ensure proper measurement. If an arrow is shown on the CT label, it should be pointed toward the load. Otherwise, use the instructions printed on the CT. If the CT was accidentally installed backwards and access to reverse it is not possible, the “CT Flipper” function can be accessed by clicking the CT “Type” in the “Logger Setup Table.” See [Physical Power Channels](#).

Connecting RōCoil CTs to a Load

- 1) Open the CT by squeezing the connector latch and pulling it apart.
- 2) Connect the CT around the load conductor to be measured. Orient the CT so that the arrow on the CT case points towards the load. Make sure the maximum current of the conductor does not exceed 5,000 amps.
- 3) Push the connector back together with the conductor within the loop of the CT.

Repeat the above three steps if you are using more than one RōCoil CT.

- 4) Connect the CTs brown wire to the negative terminal on the connector. See photo below.
- 5) Connect the CTs white wire to the positive terminal on the connector.
- 6) Twist together the bare shield wires from the RōCoils and connect to the "S" shield terminal that is part of the CH 4 connector. This reduces interference and improves accuracy of the CT.

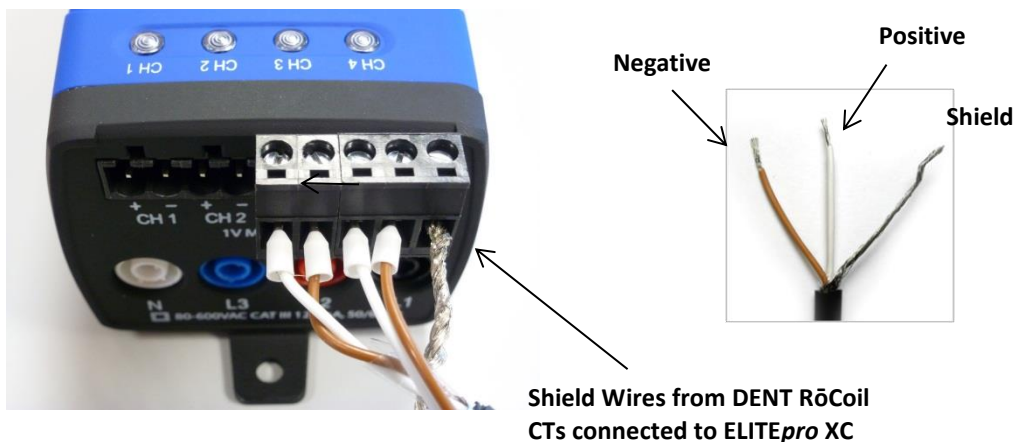
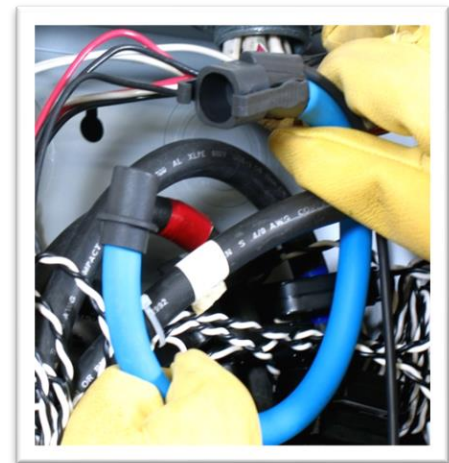

Connecting RōCoil CTs to an ELITEpro XC

VOLTAGE CONNECTIONS

- 1) Before connecting voltage leads L1, L2, L3, & N to the meter, first connect them to dedicated circuit breakers using either Croc-clips or lead adapters from DENT.
 - a) Refer to the wiring diagrams in Section 2 for wiring connection specifics. Follow local electrical codes during this installation.
 - b) **IMPORTANT:** Verify the breaker is marked as the disconnect breaker for the ELITEpro XC.
- 2) Connect lead adapters to the banana sockets at the end of the voltage leads.
- 3) Connect the voltage leads (L1, L2, L3, and N, as necessary) to the ELITEpro XC.



The ELITEpro XC is rated for 600V Over-Voltage Category III. Cat III is for measurements performed in the building. Examples are measurements on distribution boards, circuit-breakers, wiring including cables, bus bars, junction boxes, switches, and socket outlets in a fixed installation, and equipment for industrial use. Other equipment could include stationary motors with a permanent connection to the fixed installation.

ANALOG CHANNEL CONNECTIONS

Analog inputs are especially helpful when used in conjunction with power measurements to correlate the consumption of electricity with environmental, HVAC plant performance or other process conditions. Typical uses might include logging ambient temperature, building temperatures, solar insolation, tank pressures, duct flows, etc.

The ELITE XC has four analog input channels that can be configured for voltage or current input used in any combination among channels. The limiting specifications for analog input are shown in the Appendix.

The following sensor types are supported and selected through the **ELOG** software interface.

- 0/4–20 mA externally powered current loop
- 0–30* VDC single ended, non-isolated

NOTE: The ELITEpro XC can measure input voltages up to 30.0 volts. However, the polarity protection circuitry can only withstand 15 volts of reverse-applied polarity without permanent damage to the meter. The maximum allowable current flowing into the analog input terminal is 23 mA.



CAUTION: Ensure that the sensor current/voltage is within range and the channel is correctly configured using ELOG software before connecting external sensors. Sustained exposure to elevated signals may damage the ELITEpro XC and this will void your warranty.



CAUTION: Observe the correct signal polarity when connecting voltage sensors to the ELITEpro XC above 10 volts. Damaging currents may flow from the connected sensor in the event of reverse polarity or misconfiguration and this will void your warranty.

Channel types (voltage or current) should be configured using the ELOG software prior to connecting external sensors. This sequence will prevent the unexpected/unpredictable combinations of voltage transducers connected to low impedance loads (499 ohm) or current transducers with an open circuit.

The first set of Sensor and Output fields on the screen represent the *Physical Range*. This is where the user enters the low and high process values from the sensor. This data can typically be found on the data plate or data sheet of the sensor (typical sensor image below). The second set of Sensor and Output fields represent the *Electrical Output*. This is where the user enters the minimum and maximum electrical output values of the sensor, also listed on the data plate or data sheet.



Example Sensor Data Plates

Current Loop Connection

Sensors using current loops are widely used in industry to communicate analog signals in the presence of electromagnetic interference. Both 2- and 3-wire current loops (often referred to as loop powered or separately excited, respectively) are commonly used in industry. Both types of current sensors are illustrated in this section. Internally, the ELITEpro XC uses 0.1% precision 499 ohm resistors to measure the voltage drop impressed by the external current source. Current loop sensors will typically be powered from a 24-volt DC supply. The ELITEpro XC has four measurement channels. The negative terminals of each channel are common to each other and connected to the reference plane for power measurements. For this reason, it is imperative that the ELITEpro XC be connected as the last component in the current loop, rather than the first, if multiple channels are used. Best practices are to use a single power supply for all sensors to reduce the occurrence of ground loop current between supplies.

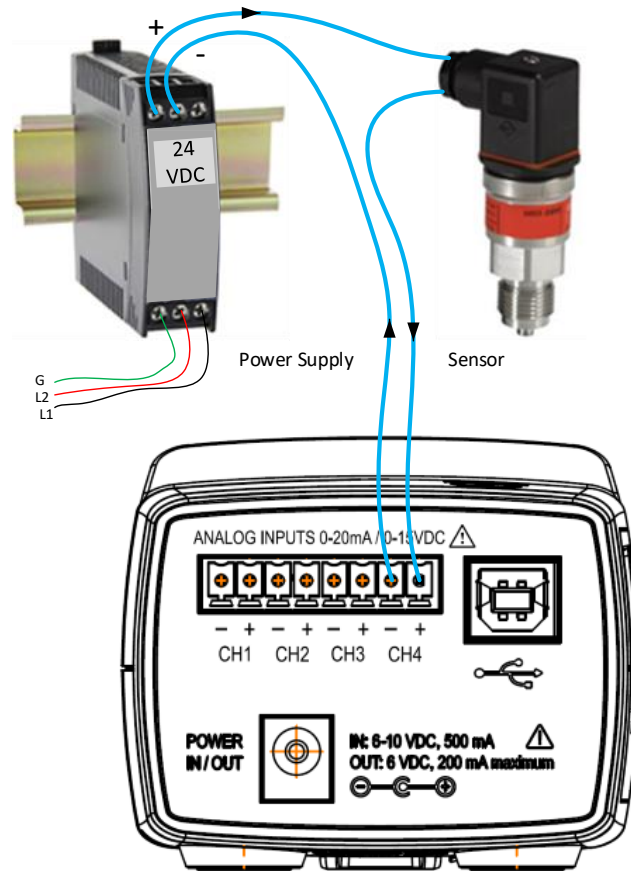

2-Wire Current Loop Configuration

Voltage Connection

Voltage output sensors and 3-wire current loops will typically use one voltage for powering the sensor and a second voltage (or current) for sending an output signal. Sometimes the power supply ground and signal reference conductor is shared between two circuits resulting in a three wire device. This economy usually comes at the installer's expense of having to form a junction at the power supply, sensor, or meter. Sensors having four terminals are also popular and are simply connected to the meter by observing the indicated polarity between sensor and meter.

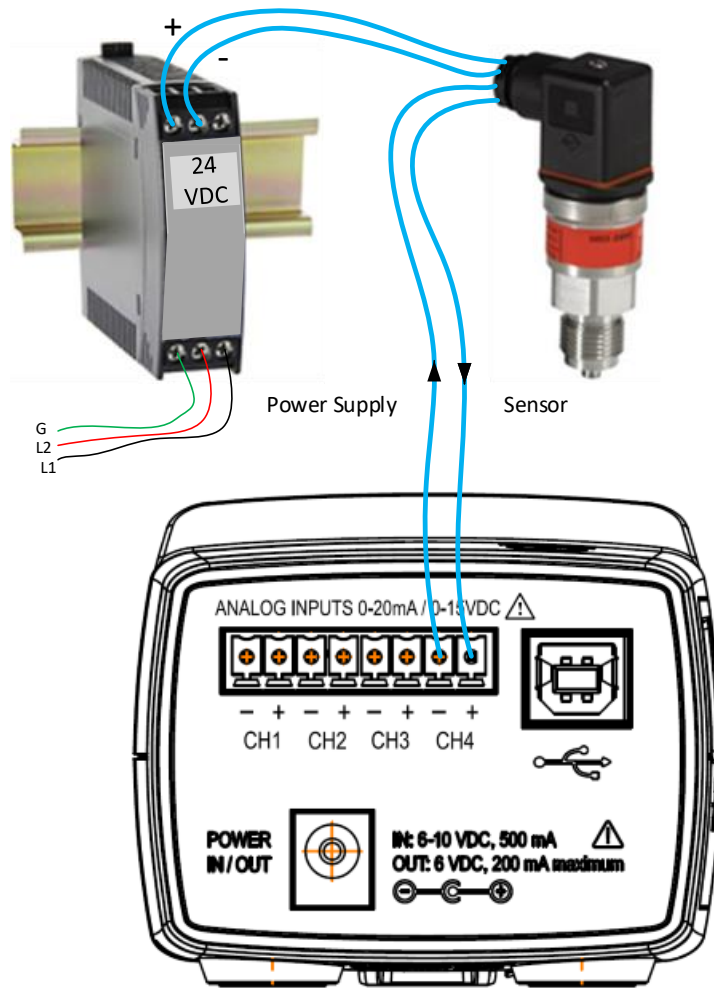

Separately Excited Current or Voltage Loop Configuration

POWER IN/OUT CONNECTION

The Power In/Out connection can be used with the ELITEpro XC to measure loads where the line voltage is less than 80 VAC and the internal power supply will not operate (a small battery bank, for example) or where AC line voltages are not available and you want to use current transformers to record amps only. It can also be used as a 6V output to power any outside devices.

- To power the ELITEpro XC using an external supply, contact DENT Instruments for an appropriately-rated power supply.
- The ELITEpro XC can also supply 6V DC at up to 200mA to an external device when the ELITEpro XC voltage leads are connected to mains power between 80 and 600 VAC.

DIGITAL CHANNEL CONNECTIONS

Digital channel connections are part of the ELITEpro SP, a legacy product produced before ELITEpro XC. Users of ELOG connected to legacy products will see digital channels instead of analog channels on the screen. The Digital channels provide users with a way to export kWh, kVAh, and kVARh pulses to external devices. The ports are grounded when closed, and floating when open. For example, if the setup table Digital 1 is configured to output KWh pulses with a Scale of 1.0, Digital channel 1 will output a pulse for each kilowatt-hour of energy measured by the meter on Power Channel 1.

In Digital 2 the Scale is set to .001 (kWh), so a pulse would be generated for each Watt-hour of energy measured on Power Channel 2. *See below.*

For example, in the Digital Channels setup below: A desk lamp with a 100W bulb will use 0.1 kWh every hour; the meter produces a pulse once every 10 hours on Power Channel 1 and 100 pulses every hour on Power Channel 2. In contrast, a 1,000W heater will use 1 kWh every hour; the meter produces a single pulse once an hour on Power Channel 1 and 1,000 pulses every hour on Power Channel 2.

Digital	Name	Power Channel	Value	Scale
Digital 1	Pulse OutPut Building 1	1	KWh	1.00
Digital 2	Pulse OutPut Building 1	2	KWh	.0010000

SEND SETUP TABLE to Logger

Digital 1/2: Turns the channels on/off by choosing an option from the drop-down list.

- 1) Connect the wires of your pulse input measuring device to the +/- pulse output connection points on the ELITEpro SP.
- 2) Using an existing setup table (or follow the steps in Section 2 of this manual to create a new one), turn on the Digital 1 and/or Digital 2 channels.
- 3) Enter a descriptive name in the **Name** field to identify your logger (optional).
- 4) Choose which **Power Channel** (CT) will be used to generate pulses from the drop-down list.

NOTE: The Power Channel drop-down list displays any enabled channel, allowing users to choose which one(s) to use as a source for the pulses.

For example, if the setup table is only configured to measure one power channel, no other options will be available in the Power Channel drop-down list. If the setup table is configured to measure two power channels, you may choose either “1” or “2” from the drop-down list.

Users may wish to output different pulse variables on each channel. The Power Channels for Digital 1 and Digital 2 may both be set to “1,” or set to “1” and “2” in order to output pulses of two Physical Power Channels, or both may be set to “2.” This enables users to output pulses with different data in the **Value** and **Scale** described in the following sections.

- 5) Select a parameter (kWh, kVARh, or kVAh) to be used as the source for pulses from the **Value** drop-down list.

The ELITEpro SP is capable of outputting pulses for kWh, kVAh, or kVARh. Only one may be outputted at a time if a single digital output channel is turned on, but users have the option of outputting two different values concurrently from the same Power Channel if both Digital 1 and Digital 2 are in use.

- 6) Enter a scale in the **Scale** field to assign a significance to the pulses.

For example, if **22** is entered in the **Scale** field and **kWh** is selected for the **Value**, then each pulse generated by the meter is equal to 22 kWh on the selected Power Channel.

- 7) Click SEND SETUP TABLE to Logger.

NOTE: The maximum output rate is five (5) pulses per second, or 5Hz, with a maximum current of 75mA and 30V DC.

NOTE: When logging is turned on or a new setup table is sent, pulse outputs start at the integration period relative to the hour that logging starts. For example, if you have a 5-minute integration period and you turn logging on at 1:05:01 PM (5 minutes and 1 second after the hour), logging AND pulse output accumulation will NOT start until 1:10:00 PM.

CONNECTING THE USB CABLE

- 1) Connect the USB cable to an available USB port on the computer and insert the other end in the USB port of the ELITEpro XC.

If a USB cable is used inside an electrical panel, it must be rated to the appropriate voltage or wrapped in an appropriately-rated insulating sleeve. The DENT-supplied cable does not meet this requirement without an insulating sleeve.

- 2) Turn on the breaker to begin metering.



Power End Panel Connections

OTHER COMMUNICATION CONNECTIONS

- The RJ-45 Connector is for Ethernet Network connections.

NOTE: The Ethernet connector accommodates high speed downloads, setup, and communication with a computer. If an Ethernet cable is to be used inside an electrical panel, it must be rated to the appropriate voltage or wrapped in an appropriately-rated insulating sleeve.

- The Coaxial connector, if present, is for an optional external Wi-Fi antenna.

NOTE: If an antenna is used inside an electrical panel, it must be at least 2" away from any live wiring or bus bars.

NOTE: An internal *Bluetooth* module is an optional communication interface.



Communication Connections

Communicating with the ELITEpro XC

- 1) Plug the USB cable into the logger and the PC. ELOG should auto-launch and connect to the **ELITEpro XC** automatically. If not, double-click the ELOG icon  on the PC desktop.

The ELOG window opens, displaying the menus and a row of speed buttons to quickly access frequently used ELOG functions.



The ELITEpro XC and ELOG software should connect automatically. If not, proceed with Step 2 below. If the automatic connection is made, proceed with Step 6 below.

- 2) Select **Tools > PC Setup** to open the **ELOG PC Setup** dialog box.

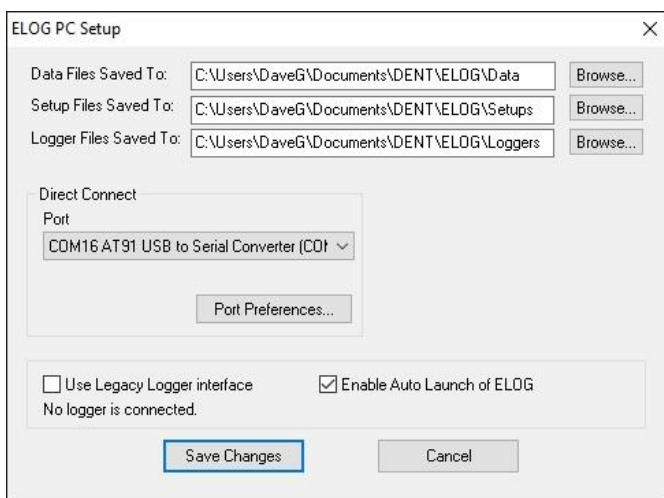

- 3) In the middle section of the dialog box labeled **Direct Connect**, select the **Port** from the menu that corresponds to the computer's COM port where the USB cable is connected.

Port Preferences: This option is used to hide COM Ports from ELOG, to change the order of COM Ports as they appear in the drop-down control, and the order they are searched when ELOG can't connect to a logger on the desired port.

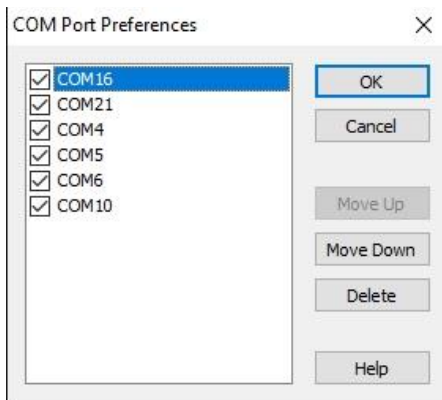

Ports that are unchecked will be hidden from ELOG. Ports are listed and searched in the order shown. The order can be changed by selecting a port and moving it up or down.

Every time ELOG connects to a logger, its port is moved to the top of this list.

- 4) Check the **Use Legacy Logger interface** checkbox to enable legacy menu items for customers using legacy products (ELITEpros). The default is unchecked, and the ELOG only displays features and menu items relevant to the current software release.
- 5) Click Save Changes.

For more information on the other **ELOG PC Setup** options see the *Tools Menu* content in Section II.

- 6) Select **Logger > Communication > Direct Connect** to connect the computer to the ELITEpro XC.

The Logger Connection information displays along the bottom of the window, providing a status message as the computer connects to the ELITEpro XC. Simultaneously, the logger's COMM LED will begin to flash.

Logger serial number/firmware version number

ELOG fills the information fields of the Logger Connection window when the computer establishes communication with the ELITEpro XC. For more information on using ELOG, see *Using the ELOG Software*.

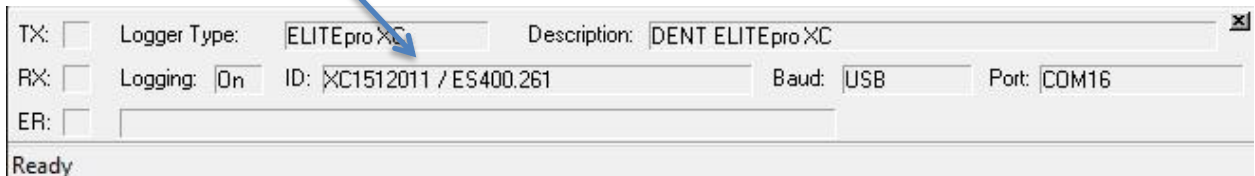

- 7) Create and send a setup table to the logger. See *Creating and Using the Logger Setup Tables* for a complete description.
- 8) Use Logger > Display Real-Time Values to verify installation.

TERMINATING THE ELITEPRO XC TO COMPUTER CONNECTION

Select **Logger > Communication > Terminate Connection** to end the connection between the computer and the ELITEpro XC.

-OR-

Use the **Disconnect**  speed button to quickly terminate the connection.

IN DEPTH USE OF THE ELITEPRO XC AND ELOG

Creating and Using the Logger Setup Tables

The ELITEpro XC is a flexible meter that can monitor a wide variety of parameters over a wide range of currents, voltages and service types. This requires that you determine what is recorded and at what intervals. The ELITEpro XC requires that it be configured for use by first creating a “Setup Table” file and then loading the file into the meter.

Setup Tables are created using the ELOG software and saved to the computer with a *.sut* file extension appended to the name. A *.sut* file may be:

- Loaded into the ELITEpro XC immediately or at a later time but prior to beginning a monitoring session
- Sent to any number of loggers
- Retrieved from an ELITEpro XC, modified and saved, and resent to the logger

CREATE A NEW SETUP TABLE

A new setup table can be created for any of the devices compatible with the current version of ELOG. This includes a variety of DENT Instruments legacy products in addition to the ELITEpro XC.

If the logger is not connected and communicating with the computer, setup tables can still be created and saved to the computer.

- 1) Select File > New > Setup Table File and click OK.

If your computer is currently communicating to an ELITEpro XC, the ELOG software assumes the new setup file is for the connected device. Selecting **New** displays a setup table with the default parameters. If no ELITEpro XC or other logger is communicating with the computer, the **Select A Setup Table Type** dialog box displays.

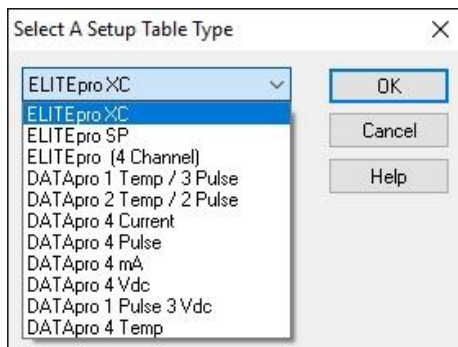

- 2) Select ELITEpro XC from the drop-down menu.

- 3) Click **OK**.

OPEN AN EXISTING SETUP TABLE ON YOUR PC

Existing setup tables on the computer can be opened, modified, and saved.

- 1) Select **File > Open** to display the Open dialog box.

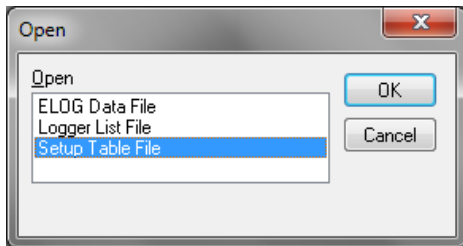

- 2) Select **Setup Table File** and click **OK**.
- 3) The Open dialog box displays. Select the desired setup table file or navigate to a folder containing additional files. The default folder is set to C:\Users\User Name\Documents\DENT\ELOG\Setups.
- 4) Select the file name and click **Open**.
-or-
Double-click the file name to open.

The setup table file can be reviewed, edited, and saved to disk or sent to the logger. For instructions on sending the file to the logger see ***Send a Setup Table to the Logger***.

RETRIEVE AN EXISTING SETUP TABLE FROM THE ELITEPRO XC

Existing setup tables on the ELITEpro XC can be retrieved once the computer and the logger are connected and communicating.

- Select **Logger > Retrieve Logger Setup Table**.

The setup table stored in the logger is retrieved and displayed, with the name of the file above the ELOG menu bar. The file can be modified and saved to disk or resent to the logger.

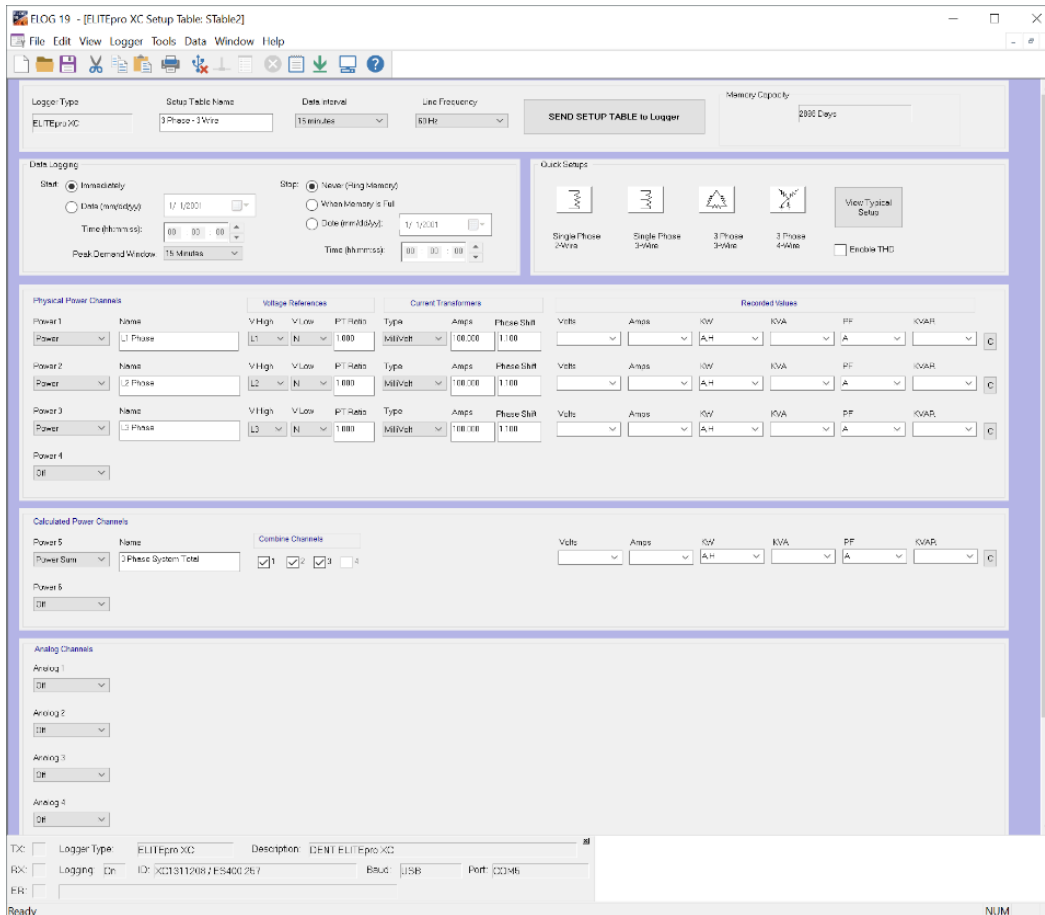

NOTE: Sections of this window are used in the following text to highlight only those areas under discussion.

CONFIGURE THE SETUP TABLE

The setup table consists of several sections where the attributes of the ELITEpro XC are defined.

Logger Type ELITEpro XC	Setup Table Name <input type="text"/>	Data Interval 15 minutes	Line Frequency 60 Hz
----------------------------	--	-----------------------------	-------------------------

Logger Type	Setup Table Name	Data Interval	Line Frequency
<p>ELITEpro XC is the default entry. This field cannot be edited once you are in the Setup Table window. Logger type is chosen from the <i>Select A Setup Table Type</i> window.</p>	<p>Enter a name for the setup table. 20-character limit. This is helpful for identifying different setup tables. NOTE: The setup table name need not be the same as the .sut file name.</p>	<p>The default integration period is fifteen minutes. The choices are 1, 3, 15, 30 seconds; 1, 2, 5, 10, 15, 20 and 30 minutes; 1 and 12 hours; 1 day. This tells the logger at what time intervals data is to be stored in the memory. For example, if the integration period is set for 30 minutes and average watts is being monitored, then every 30 minutes the logger records the average power use (watts) for that channel over the preceding 30-minute interval, based on approximately 14,400 measurements of the monitored power draw. If Maximum (and/or Minimum) values are being recorded the highest (and/or lowest) of those 14,400 readings are also saved.</p>	<p>Auto, 60 Hz, or 50Hz. Default is 60 Hz.</p>

DATA LOGGING CONTROLS

The Data Logging section controls when the logger starts and stops collecting data. The default values are **Start Immediately** and **Stop Never (Ring Memory)**. Additional data logging options are defined below.

Start Options

Immediately	Logging starts as soon as the setup table is sent to the logger.
Date (mm/dd/yy)	Logging starts at the designated date and time.
Time (hh:mm:ss)	Time should be set in a 24-hour format, e.g., 2:30PM should be entered as 14:30.
Peak Demand Window	The default is 15 Minutes. Choices are Off, 1, 2, 3, 4, 5, 6, 10, 12, 15, 20, 30, and 60 minutes.

Stop Options

Never (Ring Memory)	Logging is continuous, meaning when memory fills, the oldest records are replaced with the newest records, allowing for long term metering projects.
When Memory Is Full	Logging stops when the memory is full.
Date (mm/dd/yy)	Logging stops at the designated date and time.
Time (hh:mm:ss)	Time should be set in a 24-hour format, e.g., 2:30 pm should be entered as 14:30.

MEMORY CAPACITY

ELOG provides a convenient feature that calculates the approximate length of time required to fill the memory for any setup table. The feature is dynamic so that any time any parameter in a setup table affecting the memory duration is changed, the Memory Capacity field is updated, providing the (new) length of time the logger's memory will last. The ELITEpro XC has 16 MB internal non-volatile memory.

QUICK SETUPS

The Quick Setups section of the window provides four buttons to quickly configure the ELITEpro XC.

- 1) Click the **Quick Setup** button that represents your monitoring scenario.

Each button opens the CT Selection dialog window.

See **ELOG Quick Setup Wiring Diagrams** within this section for more detail.

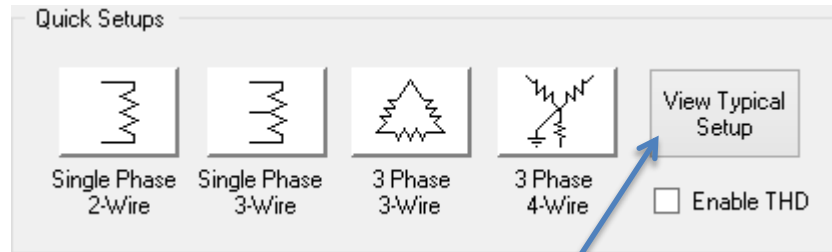

The **View Typical Setup** button is only visible *after* a Quick Setup selection is made.

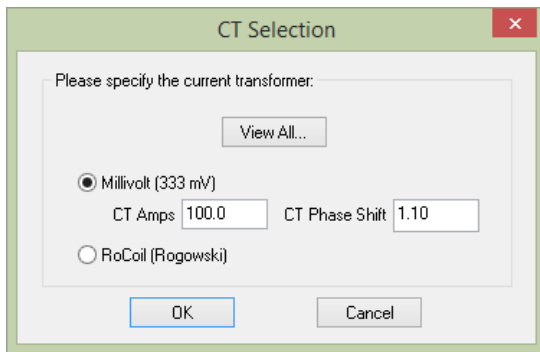

- 2) Select **View All** to choose a CT from the CT selection list.

-or-

Select **Millivolt** and enter the **CT Amps**, the primary current rating of the current transformer, and the **CT Phase Shift**.

-or-

Select **RöCoil**.



The Millivolt default is 100 amps. Enter the value printed on the CT if it is not 100. If RöCoil (Rogowski) is selected, the CT Amps are set to 5,000 and the CT Phase Shift is set to 0.0 and may not be changed. All DENT RöCoils, regardless of size, use the same settings.



Power Channel Setup Help: The Power Channel Assistant can be opened to guide a new user through the Setup Table step-by-step. It includes helpful explanations of each parameter as well as a key to recording flag abbreviations. The Power Channel Assistant can be accessed by starting a new Setup Table and going to **Help > Power Channel Setup Help**.

Current Transformers		Recommended CT Phase Shift Values
Clamp On	CT-CON-0150EZ	1.10°
	CT-CON-1000	0.20°
Split Core Small	CT-SCS-0050	2.20°
	CT-SCS-0100	2.20°
Split Core Medium	CT-SCM-0100	1.75°
	CT-SCM-0200	1.50°
	CT-SCM-0400	1.30°
	CT-SCM-0600	1.30°
Split Core Large	CT-SCL-0600	0.00°
	CT-SCL-1000	0.00°
Hinged Mini	CT-HSC-020	0.75°
	CT-HSC-050	0.75°
Hinged Midi	CT-HMC-0100	0.12°
	CT-HMC-0200	0.30°
Revenue Grade Toroidal Solid Core	CT-RGT12-0005	0.00°
	CT-RGT12-0020	0.00°
	CT-RGT12-0050	0.00°
	CT-RGT12-0100	0.00°
Revenue Grade Split Core	CT-SRS-005	-0.10°
	CT-SRS-050	-0.23°
	CT-SRL-100	0.06°
	CT-SRL-200	0.06°
	CT-SRL-400	-0.06°

Recommended CT Phase Shift Values

- 3) Click **OK**.
- 4) Check the **Enable THD** checkbox if you want total harmonic distortion to appear as a percentage in the Data File Summary report. Selecting this option automatically populates any required value field necessary to determine distortion.

Once the Quick Setup is completed, the **View Typical Setup** button appears in the Quick Setup area of the screen. Clicking this button displays a wiring diagram showing how to connect the CTs and the voltage leads of the ELITEpro XC corresponding to the selected setup. The diagram can be printed and carried into the field for easy reference during installation. Refer to *ELOG Quick Setup Wiring Diagrams* for detailed information of each Quick Setup option.

Additionally, depending on the setup, **Calculated Power Channels** with configuration options display in the lower section of the Setup Table screen.

PHYSICAL POWER CHANNELS

The ELITEpro XC has four configurable hardware channels corresponding to the current.

- 1) Click on the maximize button in the upper right-hand corner of the Setup Table window to display as much of the full screen as possible.

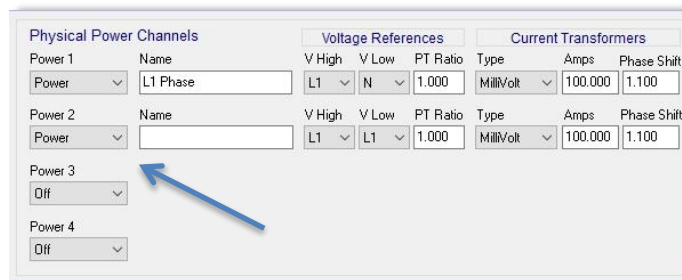

- 2) Click on the down arrow next to each channel you want to configure.

CT 1 must be placed on the phase listed as V High for Channel 1 in the ELOG setup table. CT2, CT3 and CT4 must also correspond to the appropriate phase as shown in Channels 2, 3, and 4 in the ELOG setup table.

- 3) Select **Power** to turn on any channel. These channels refer to the current transformer inputs from the ELITEpro XC. Selecting **Power** displays the options for configuring the channel.
- 4) Enter a name for the channel, then select the Voltage References, Current Transformers, and any Recorded Values.

NOTE: The PT Ratio is used when monitoring voltages greater than 600 VAC (maximum rating of the ELITEpro XC). Use an instrument grade transformer with low phase shift and high accuracy since errors in the transformer will translate directly into errors in the recorded data. The PT Ratio value put into the Setup Table in the logger should be the transformer primary:secondary ratio. This feature is useful when monitoring high voltage loads such as found at a substation or on transmission lines.

For example, a potential transformer is used to monitor a 4160 VAC load. The transformer steps the voltage down from 4160 to 120 VAC. The PT equals the transformer ratio or $4160/120 = 34.667$. Thus, 34.667 would be used for the PT value in the channel Setup Table.

The drop-down list in the **Type** field of the Current Transformers section contains a View All option that opens the **Select a CT from the list** window displaying images of CTs with their recommended amps and phase shift. Selecting a CT from that window automatically populates the Amps and Phase Shift fields with the CT's recommended values.

- Double-click on any image.
-or-
Select an image and click **OK**.

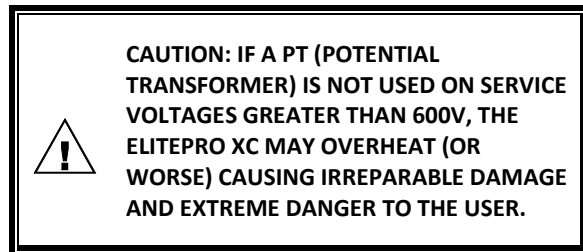
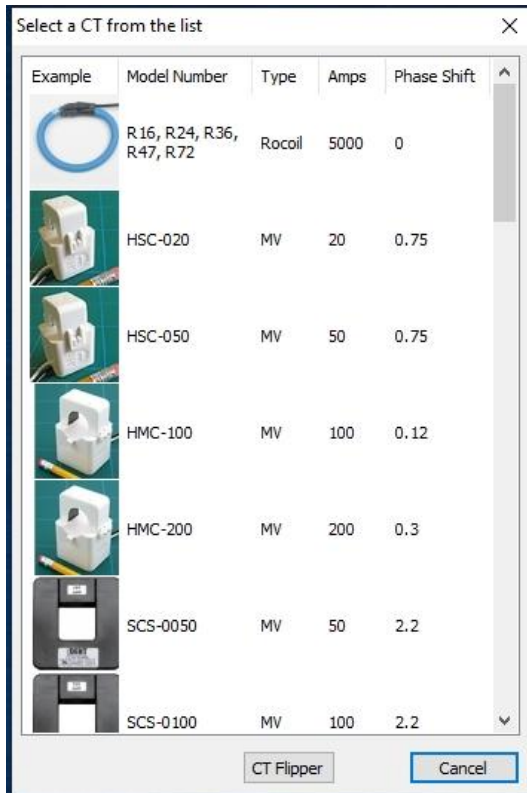

CT Flipper: Quickly change the order of voltage references for a particular channel by clicking the CT Flipper button. The CT Flipper can be found by clicking on the CT Type dropdown in the Setup Table and clicking the CT Flipper button. A pop-up window alerts you when the CT has been flipped.

The **Recorded Values** of a power channel tell the logger what parameters you wish to record and can be configured by selecting any combination of **Volts**, **Amps**, power (**kW**), volt-amperes (**kVA**), power factor (**PF**), and volt-amperes-reactive (**kVAR**) as desired for each channel you turned on.



For a description of the Recorded Values and their formulas for the Calculated Power Channels, see **Calculated Power Channels**.



Copy Button: Clicking the “C” (copy) button at the end of the Recorded Values Row can be used to quickly copy a set of recording flags from one channel to another.

The following options are available for configuring Physical Power Channels.

Physical Power Channel Options		
Name	Name the channel so it describes the location or item being monitored, such as "Water Heater" or "Pump L1 Phase." A maximum of 20 characters is allowed.	Optional
V High	High-side voltage. This is the “high” reference voltage that will be measured with respect to the reference “low” voltage, V Low.	Choices are: L1, L2, L3, Neutral.
V Low	Low-side voltage; reference for AC voltage.	Choices are: L1, L2, L3, Neutral.
PT Ratio	Potential Transformer turns ratio. This is used when a step-down transformer is needed to measure AC voltages greater than 600V. The default is 1.000.	
Type	This is the type of CT connected to the ELITEpro XC	Choices are: MilliVolt or RōCoil.
Amps	Depends on the type of CT selected. Displays the value entered in the CT Size screen.	
Phase Shift	Compensate for CT Phase Shift with this setting. Default setting is 1.1 degrees.	
Volts Amps KW KVA PF KVAR	To record any or all of these values use the menu to select an option.	Choices are: Average, Minimum, or Maximum. In addition, the integrated hourly value in an option where appropriate.

See ***Power Measurement—Connecting CTs and Configuring Channels*** for information on how to properly configure the Setup Table for single-phase 2-wire, single-phase 3-wire, 3-phase 3-wire, and 3-phase 4-wire services.

CALCULATED POWER CHANNELS

Channels 5 and 6 are the Calculated Power Channels. They combine the data from two or more power channels (also called "hardware" or "physical channels") and are used primarily for calculating *total system* volts, amps, kW, kVA, power factor, and kVAR in polyphase or multiple single-phase systems.

Channel	Name	Combine Channels	Volts	Amps	KW	KVA	PF	KVAR
Channel 5	2 Phase System Total	<input checked="" type="checkbox"/> 1 <input checked="" type="checkbox"/> 2 <input type="checkbox"/> 3 <input type="checkbox"/> 4	A,X	A,N,X,H	A	A,N,X,H	A	N,X
Channel 6	3 Phase System Total	<input checked="" type="checkbox"/> 1 <input checked="" type="checkbox"/> 2 <input checked="" type="checkbox"/> 3 <input type="checkbox"/> 4	A,N	A,N	A,X	A,X,H	A,N	A,N

The Calculated Power Channels are frequently used to:

- Record total system power parameters on three phase loads.
- Optimize the logger's memory by collecting and combining data from two or more channels instead of collecting data from two (or more) separate channels.

For a description of the formulas used to compute channels 5 & 6 based on the CT input channels 1–4, see **Appendix D—Calculated Power Channel Formulas**.

Combining Channels

To combine channels and maximize memory use:

- Depending on your setup table configuration, ensure that the Physical Power Channels you wish to combine are set to **Power**.

It is recommended that the Recorded Values flags of Volts, Amps, kW, kVA, PF, and kVAR for the individual channels be left on. However, if maximum use of the memory is required, they can be turned off.

Default recording flags may have the Average checkbox selected in each drop-down menu for the Recorded Values.

- Under **Calculated Power Channels**, turn on the channel by selecting **Power Sum** from the Channel 5 menu. Perform the same function for Channel 6, if desired.
- Enter a name for the Calculated Power Channels (optional).
- Select the **Physical Power Channels** to be added together in the Combine Channels box.
- Set each recording flag for **Volts, Amps, kW, kVA, PF, and kVAR** as desired.
- Click **Send Setup Table to Logger** to send the setup table to the logger and make it the active table.

The following graphic is an example of a Setup Table for a 3-phase 4-wire connected load using a Calculated Power Channel with **Combine Channels 1, 2, and 3** selected to optimize memory usage on the ELITEpro XC.

The screenshot shows the configuration interface for the ELITEpro XC. It is divided into two main sections: 'Physical Power Channels' and 'Calculated Power Channels'.

Physical Power Channels: This section contains three rows for Power 1, Power 2, and Power 3. Each row has a 'Name' field (L1 Phase, L2 Phase, L3 Phase), 'V High' (L1, L2, L3), 'V Low' (N), 'PT Ratio' (1.000), 'Type' (MilliVolt), 'Amps' (100.000), and 'Phase Shift' (1.100) fields. Power 4 is set to 'Off'.

Calculated Power Channels: This section contains two rows for Power 5 and Power 6. Power 5 is set to 'Power Sum' with the name '3 Phase System Total'. It has a 'Combine Channels' section with checkboxes for 1, 2, 3, and 4, where 1, 2, and 3 are checked. Power 6 is set to 'Off'.

NOTE: The Recorded values listed to the right of the Current Transformers section on the Setup Table are not shown in this graphic.

ANALOG OUTPUT CHANNELS (ELITEPRO XC ONLY)

The screenshot shows the configuration interface for the Analog Channels. It contains four rows for Analog 1, Analog 2, Analog 3, and Analog 4. Each row has a 'Name' field, 'Electrical Signal Range' (Min, Max, Units), and 'Process Value Range' (Min, Max, Units) fields. A 'Record' field is also present for each channel. A blue arrow points to the drop-down menu for Analog 2, which is currently set to '4 - 20 ma'.

NOTE: Turn the analog channels on/off by choosing an option from the drop-down list.

- 1) Select **Current/Voltage/Off** from the drop-down menu for the channel type. Additional fields display on the Setup Table screen when an analog channel current or voltage is selected.
- 2) Enter a descriptive name in the **Name** field to identify your measurement. This name appears in the retrieved logger data header.
- 3) Enter the raw sensor output minimum/maximum values. This data is typically found on the data plate or data sheet of the sensor. Typical values for voltage devices are 0-5, 1-5, 0-10, 0-15, 0-30 for voltage devices and 0-20, 4-20 for current loop devices.

- 4) Enter the corresponding engineering value to the sensor range (i.e., *psig*), the units, and the average, minimum, and/or maximum record.
- 5) Click **Send Setup Table to Logger** to load the configuration into the data logger.

Best practices are to confirm the operation of all sensors. Use **Logger > Display Real Time Values > Show as Text** or click the **Display Real Time Text Values** speed button before commissioning the logger for prolonged data logging projects.



To troubleshoot or calibrate a current or voltage sensor, it is convenient to set the physical range fields to be equal to the electrical output values. The Real Time Values readings can then be compared directly with voltage or current measurements taken from a DVM. Offset or gain errors can be corrected by adjusting the minimum value or span (max-min).

SEND A SETUP TABLE TO THE LOGGER

When you've finished selecting the configuration options, the setup table needs to be sent to the ELITEpro XC.

- 1) After connecting to the logger, click on one of the **SEND SETUP TABLE to Logger** command buttons on the Setup Table screen. Separate buttons are available at the top and lower left of the Setup Table screen. Sending a new setup table to the logger deletes any data still stored in the logger. ELOG displays the following dialog box to ensure desired data is not lost:

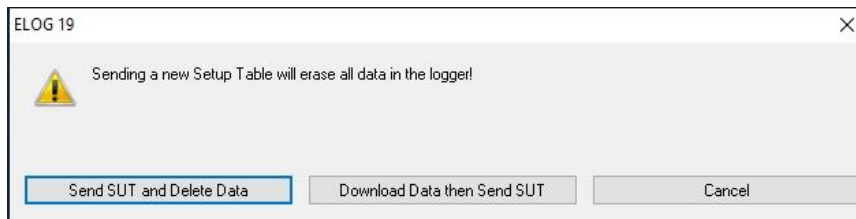

- 2) Click **Send SUT and Delete Data**. This loads the new setup table into the meter and clears the data in the logger. The **Logging is now ON** dialog box briefly displays.
 - or-
 - Click **Download Data then Send SUT**. The **Select A Directory and A Name...** dialog box displays. Enter the name and location for the data file. After the data is downloaded to the PC and saved, ELOG automatically sends the new setup table to the meter and starts logging.
 - or-
 - Click **Cancel**.

ELOG automatically initiates logging when a setup table is downloaded to the logger unless the Data Logging delayed start time is being used.

- 3) Select **Logger > Display Real-Time Values > Show As Text** to view the real-time values measured by the logger.

CH	Channel Type	Channel Values						
1	POWER L1 Phase	1.681 V	0.53 A	0.000 kW	0.001 kVA	0.71 dPF	0.000 kVAR	***** % THD
2	POWER L2 Phase	1.681 V	0.53 A	0.000 kW	0.001 kVA	0.71 dPF	0.000 kVAR	***** % THD
3	POWER L3 Phase	1.681 V	0.53 A	0.000 kW	0.001 kVA	0.71 dPF	0.000 kVAR	***** % THD
4	POWER	1.681 V	0.53 A	0.000 kW	0.001 kVA	0.71 dPF	0.000 kVAR	***** % THD
5	POWER SUM 3 Phase System Tot	1.681 V	0.53 A	-0.004 kW	0.004 kVA	0.71 dPF	-0.004 kVAR	
6	Off							

CH	Channel Type	Channel Value
1	0 - 10 Vdc Pump Pressure	7.575 vdc
2	4 - 20 ma Ambient Temp	15.365 ma
3	Off	
4	Off	

Line Frequency: = Parameter Logged Display Update: ON

Memory Remaining: 1976.24 Days Logger Date: 02/12/2019 Logging Is: On

Memory Used: 0.0% Logger Time: 13:43:59 Memory Type: Ring Integration Period: 15 Minutes

SAVE A SETUP TABLE ON THE COMPUTER

When you've finished selecting the configuration options, the setup table can also be saved for downloading to the ELITEpro XC at a later time.

Select **File > Save** to save the setup file to the hard drive or **Save As** to save to the hard drive using a different file name or folder location.

Monitoring can begin once the ELOG software is configured and the ELITEpro XC is connected. The following sections of this chapter provide assistance in making sure the logger is performing correctly.

LED Diagnostics

PHASECHEK™ LEDs

PhaseChek is a unique feature of DENT meters that simplifies installation by ensuring proper CT-to-voltage phase installation and avoiding faulty data collection.

The ELITEpro XC has four tri-color PhaseChek LEDs, one green/red/blue LED for each CT input. These LEDs provide the following information:

- All LEDs are green—the system power factor is greater than 0.55 and the CTs are properly placed on the corresponding voltage phases and the CT is oriented properly (arrow toward the load).

- LED is red—there is a CT voltage phase placement error (or the Power Factor is less than 0.55)
- LED is blue—the CT is on backwards (-kW) with the arrow pointed away from the load
- LED flashes red and blue—CT is on backwards and on the wrong voltage phase



If the total system power factor is less than 0.55, the LEDs will be red even if connected properly. This situation is rare but could occur if, for example, the load to be monitored is a lightly loaded electric motor. It is common for an individual phase power factor to be less than 0.55 and the corresponding LED will be red.



If the Physical Power Channel (CT) is turned off in the setup table, the corresponding PhaseChek LED will be dark.

COMM—COMMUNICATIONS LED

The ELITEpro XC COMM LED flashes different colors (green, blue, red) to indicate that the logger is connected, logging information, and communicating with the computer. Green will flash approximately once per second when the ELITEpro XC is logging and communicating with the computer.

Power Measurement—Connecting Sensors & Configuring Channels

The ELITEpro XC can monitor AC power loads ranging from 1-phase, 2-wire to 3-phase, 4-wire systems and up to 600 VAC at 50 or 60Hz.

Read all warning symbols described in the Safety section **AT THE BEGINNING OF THIS MANUAL**.

Use the proper Current Transformers (CTs) for the load being monitored. For a complete discussion on this, see the section *Current Transformer (CT) Selection* below.



CAUTION: DO NOT USE UNSHUNTED CTs. ONLY USE SHUNTED CTs FROM DENT INSTRUMENTS WITH 333 mVAC OUTPUT. ALL DIAGRAMS IN THIS SECTION SHOW THE CT PHASING ARROW POINTING TOWARD THE LOAD.

Always orient the arrow on the CT towards the load or as otherwise indicated on the CT. All diagrams in this section will show the CT phasing arrow oriented towards the load. **If the CT was accidentally installed backwards and access to reverse it is not possible, the “CT Flipper” function can be accessed by clicking the CT “Type” in the “Logger Setup Table.”** See [Physical Power Channels](#).



WARNING: Use of this device in a manner for which it is not intended may impair its means of protection. Do not exceed 600 VAC voltage inputs!



When connecting the ELITEpro XC to an AC load, follow these steps in sequence to prevent a shock hazard.

- 1. If possible, de-energize the circuit to be monitored.**
- 2. Connect the CTs to the phases being monitored.**
- 3. Connect the voltage leads to the different phases. Use proper safety equipment (gloves, mask, and protective clothing) as required for the voltages monitored.**

WIRING LABEL CONVENTIONS

When connecting the voltage wires to the AC line, the following wire colors should be used for the different phases:

Voltage Phase	United States (Voltage Phase Color)	International (Voltage Phase Color and Wire Label)
L1 phase	Black	Follow local code
L2 Phase	Red	Follow local code
L3 Phase	Blue	Follow local code
Neutral	White	Follow local code

ELITEpro XC Voltage Phase Wire Colors



U.S. color conventions are used in the document’s diagrams. ELITEpro XC meters supplied for international markets are provided with 5 colors of voltage leads: red, black, blue, white, and yellow. The voltage lead sockets on the meter are all black in color and labeled L1, L2, L3, and N.

CURRENT TRANSFORMER (CT) SELECTION



The UL listing covers the use of the following DENT Instruments CTs that are UL Recognized and have been evaluated to IEC 61010-1:

CT-HSC-020-X (20A Mini), CT-HSC-050-X (50A Mini), CT-HMC-0100-X (100A Midi), and the CT-HMC-0200-X (200A Midi), and CTs that are UL listed to UL2808.

Though all other CTs provided by DENT Instruments have been tested and certified to the same IEC 61010-1 standard by other Nationally Recognized Testing Laboratories (NRTLs), the use of any other CT will invalidate the UL Listing of the ELITEpro XC. This is simply a decision made by UL, and in the opinion of DENT Instruments, all CTs provided are equally safe to use.

Proper CT selection is critical for accurate results. Use CTs with the smallest diameter to fit around the wire(s), and whose rated amperage is not less than 100% of the largest load expected.

Generally, best CT accuracy will result when the load operates *as close to the full rating* of the CT as possible. Do not use CTs whose maximum current rating greatly exceeds the maximum current of the load of the item being monitored.

The following table contains a list of some of the DENT Instruments CTs.

Mini	Small Split Core	Midi	Medium Split Core	Large Split Core	Clamp-On	Revenue Grade Split Core	RōCoil (Rogowski)
20A	50A	100A	100A	600A	150A	5A	5,000A
50A	100A	200A	200A	1000A		50A	
			400A			100A	
			600A			200A	
						400A	

Current Ratings of CTs Available from DENT Instruments

These are internally shunted CTs (333.3 mV output) which make them safe to handle even when connected to an energized wire. They are also case-insulated for 600V phase-to-phase service. Do not use on services with higher voltages.

The following table is a list of the UL recognized (61010-1) CTs that maintain the UL listing.

Mini	Midi	Revenue Grade	RōCoil (Rogowski)
CT-HSC-020-U	CT-HMC-0100-U	CT-SRS-005	CT-RXX-1310-U
CT-HSC-050-U	CT-HMC-0200-U	CT-SRS-050	CT-RXX-A4-U
		CT-SRL-100	
		CT-SRL-200	
		CT-SRL-400	

UL Recognized CTs



You can extend the leads for a RōCoil up to 100 feet and a split core up to 1000 feet without a loss of accuracy, provided that the new wire is of the same gage or larger than the CT lead wire.



CAUTION: DO NOT USE UNSHUNTED CTs. ONLY USE SHUNTED CTs WITH 333 mVAC OUTPUT. ALL DIAGRAMS IN THIS SECTION SHOW THE CT PHASING ARROW POINTING TOWARD THE LOAD.

CT SELECTION EXAMPLES

The following table provides three example scenarios for selecting the proper CT.

Example	Scenario Description	Correct CT
1	A single-phase motor with a 20 amp breaker (rated as 10 amps running load) with #12 wire.	Use a 20 or 50 amp split core or 150 amp clamp-on
2	Four lighting circuits, #12 wires with 20 amp breakers. When all lights are on, the amperage measures 45 amps.	Use a 50 amp CT
3	A single heating circuit, with a 2/0 conductor and a 60 amp breaker.	Use a 100 amp CT

Example Scenarios for CT Selection



If a utility already has a meter with a 5A secondary CT(s) connected to a load being monitored, you may connect a 5A split core CT around the output (secondary) of the utility's CT. To calculate the CT value to be used in the Logger setup table, multiply the utility CT ratio by the ELITEpro XC CT size (e.g. if the utility CT is 4000:5 and the DENT CT is 50A use $(4000/5) \times 50 = 40,000$ for the value of the CT in the logger Setup Table.

CONNECTING CTs AND CONFIGURING CHANNELS

This section describes how to connect the CTs and the voltage leads to different service types, and how to configure the ELITEpro XC channel(s) for monitoring.

- 1) Connect each CT lead to the channel pins of the black connector termination block.

For each channel, the left connector pin is the positive, or high-side, wire and the right pin is the negative, or low-side. Connect DENT Instruments-supplied current transformers as follows:

- Split-core CTs (removable leg) and hinged CTs—The white CT wire is (+) and the black wire is (-)
- Clamp-on CTs (clothes pin type)—The red lead is the (+) wire and the black lead is the (-) wire
- RōCoils— The white lead is the (+) wire and the brown lead is the (-) wire (bare wire is shield)



Correct polarity is required to ensure proper orientation of the CT. A CT with the lead wires switched on the connector is the same as putting the CT on the monitored wire backwards.

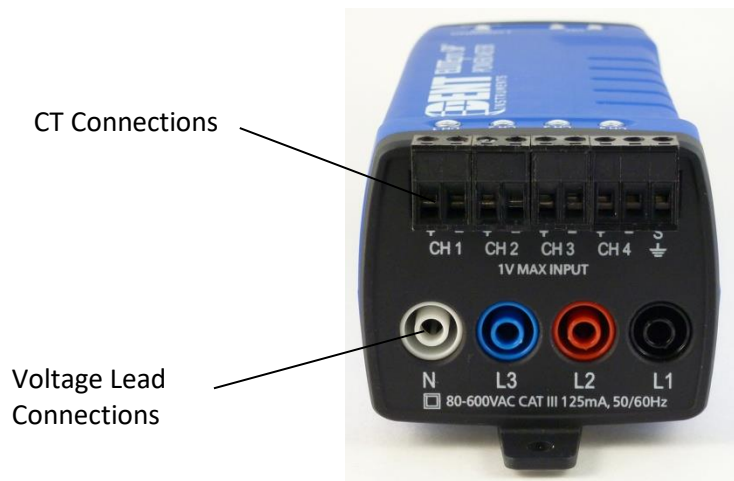

ELITEpro XC End View of CT and Voltage Lead Connections

- 2) Apply the CTs to the phases being monitored observing proper CT orientation.
- 3) If there is an arrow on the CT label, the label should point towards the load. Otherwise, use the instructions printed on the CT, for example: "This Side Toward Load."
- 4) Connect the voltage leads to the different phases. Connect the Neutral wire first, then the remaining voltage sense (phase) wires.

ELOG QUICK SETUP WIRING DIAGRAMS

When a Quick Setup is selected, the **View Typical Setup** button appears in the Quick Setup area of the screen. Clicking this button displays a wiring diagram that corresponds to the selected setup, showing how to connect the CTs and the voltage leads of the ELITEpro XC. The diagram can be printed and carried into the field for easy reference during installation.

The following pages show the diagrams available for each Quick Setup.

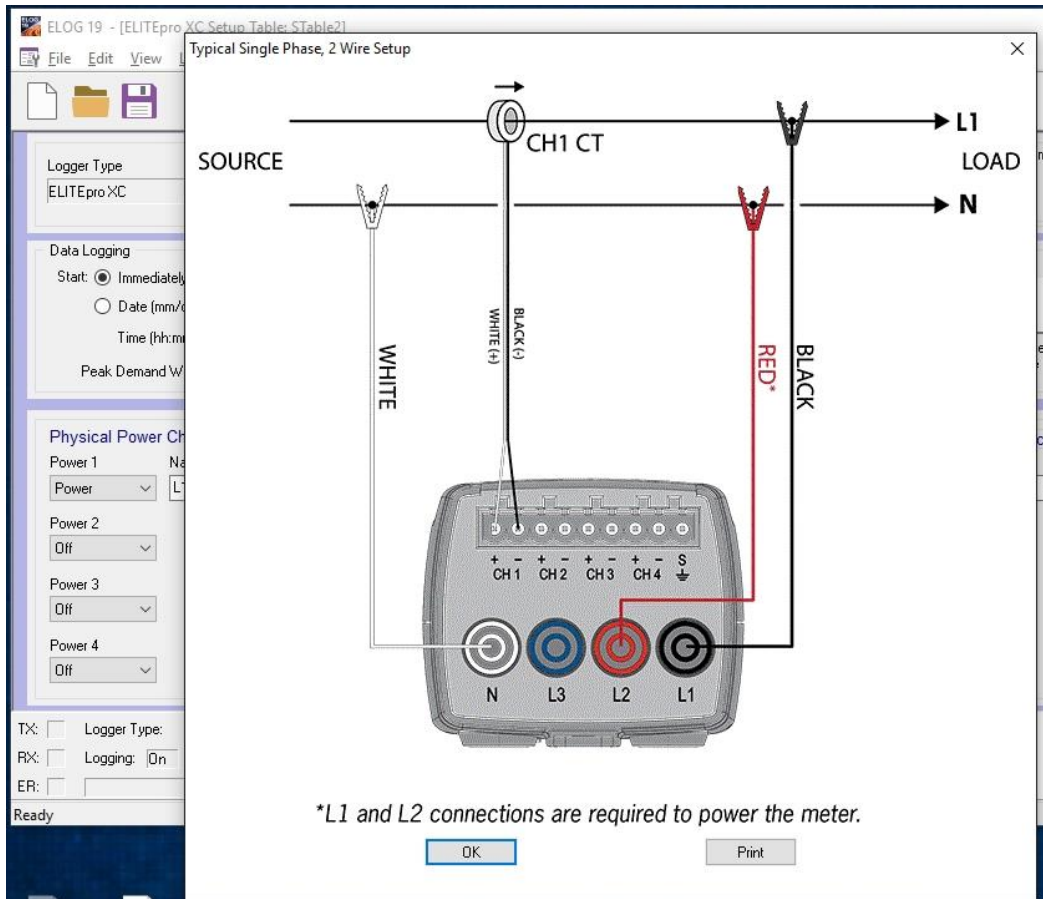

Typical Single Phase, 2-Wire Setup Diagram

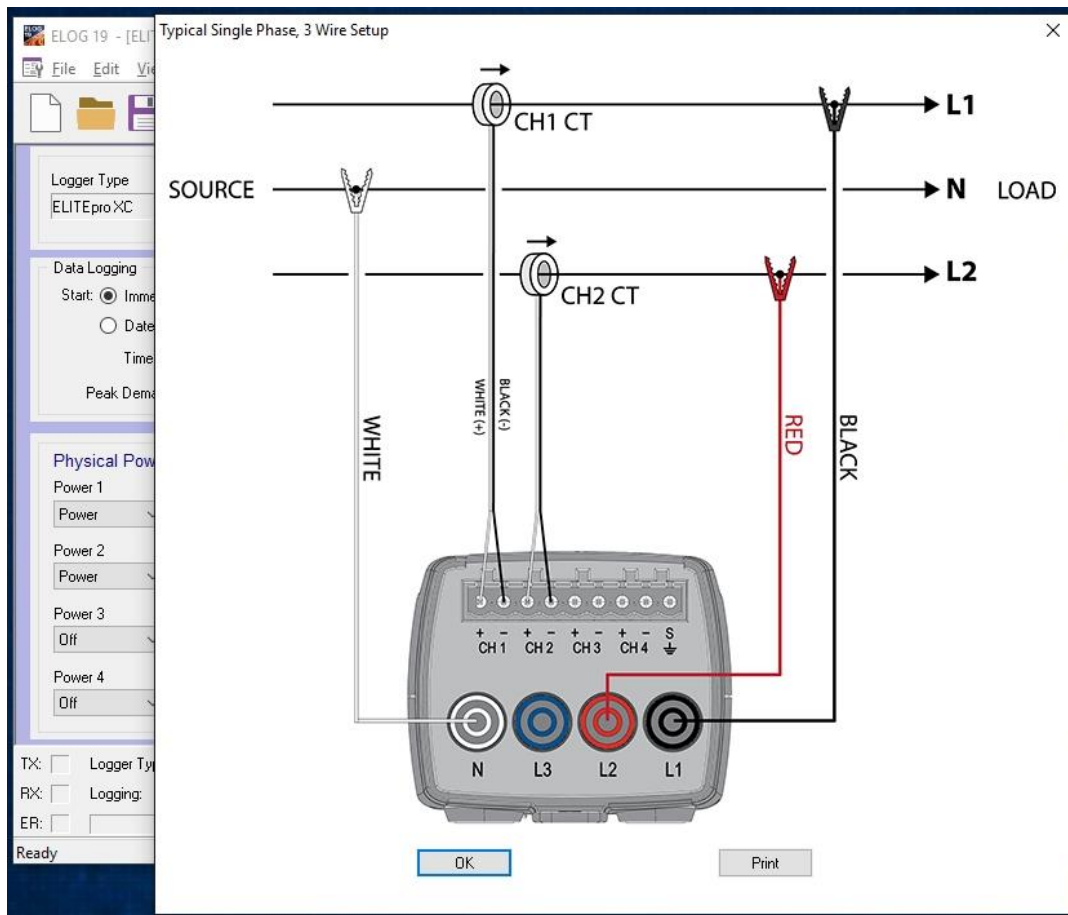

Typical Single Phase, 3-Wire Setup Diagram

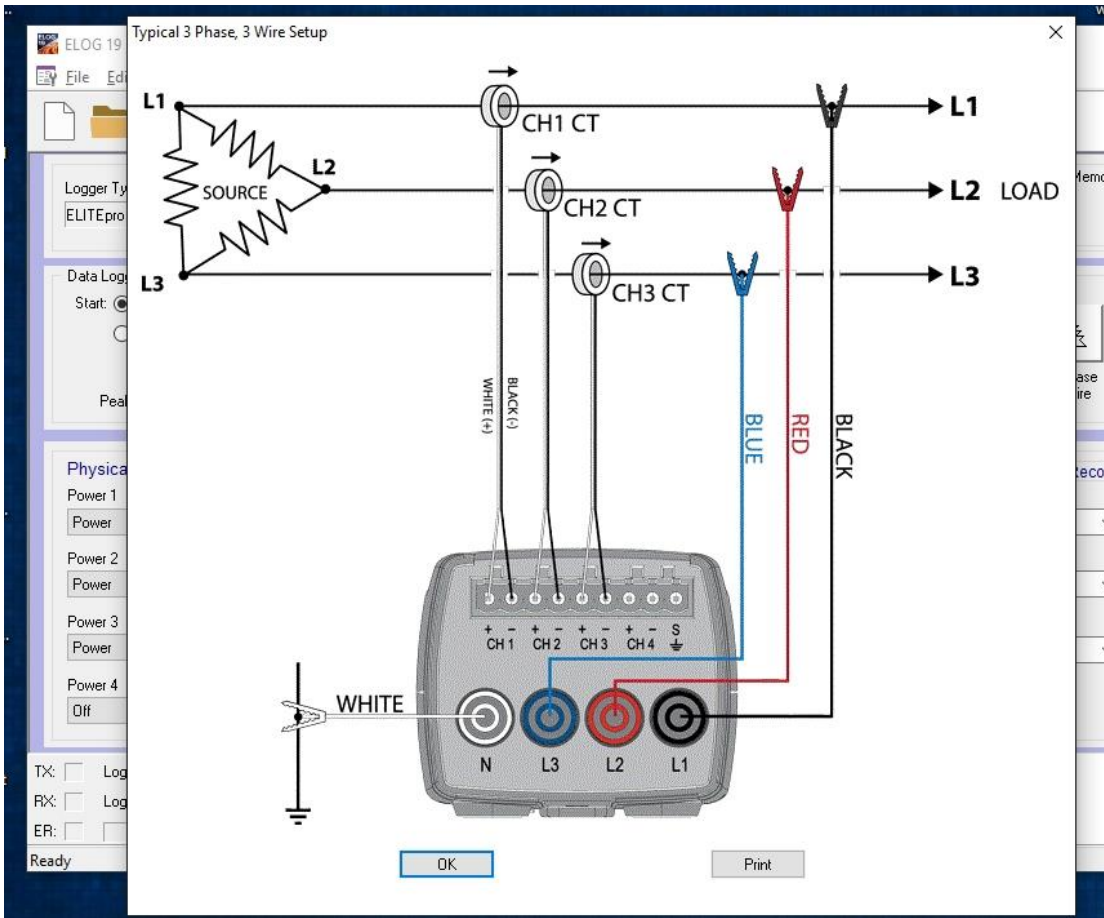

Typical 3 Phase, 3-Wire Delta Setup Diagram

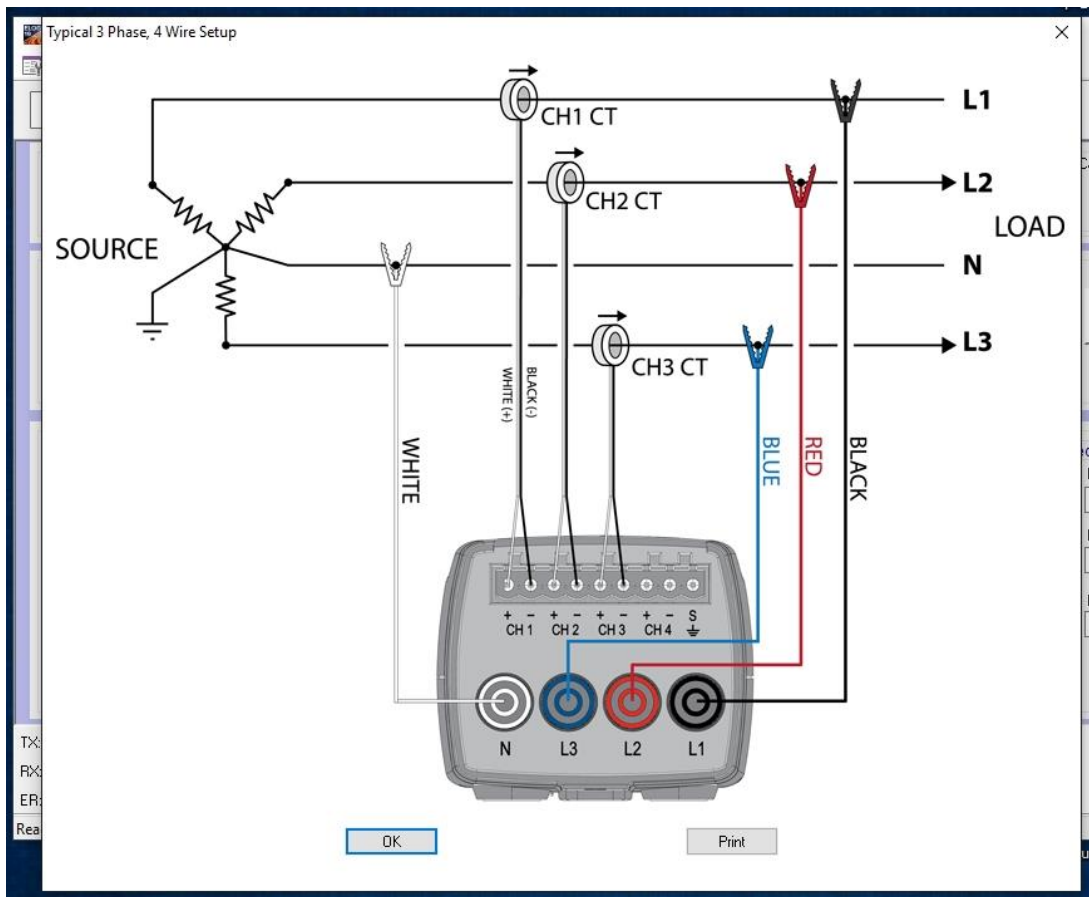

Typical 3 Phase, 4-Wire Wye Setup Diagram



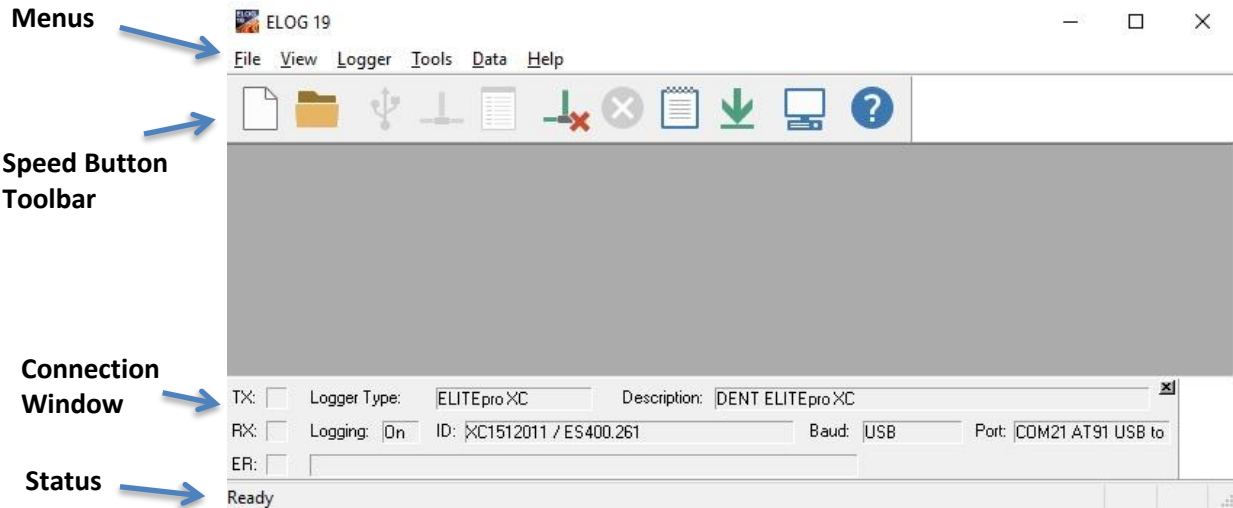

Using the ELOG Software

When ELOG starts, the window is empty until a task is requested, whether that be opening an existing Setup Table, creating a new one, or importing a data file. The following window displays with the ELOG menus and buttons for accessing frequently used ELOG features.



ELOG SPEED BUTTONS

The ELOG speed buttons enable users to quickly navigate between commonly used functions. For example, to connect between the computer and the ELITEpro XC over a serial or *Bluetooth* connection, use the  button instead of the menu commands **Logger > Communication > Connect Via...** The button toolbar can be toggled on and off by selecting the **View > Toolbar** option. A description of each button follows.

- 
New Create a new Setup Table, Logger List, Data File (download), or Graph
- 
Open Open an existing Setup Table, Logger List, Data File, or Graph
- 
Save Use to save changes to modified items in ELOG
- 
Cut Performs the standard cut data function
- 
Copy Performs the standard copy data function

	Paste	Performs the standard paste data function
	Print	Print the active window
	Direct Connection	Use for connecting the logger to the computer when using a USB cable or <i>Bluetooth</i>
	Network Connection	Use for Wi-Fi, Access Point-to-Point mode, or Ethernet connection
	Choose from last used Logger List	Use to connect to a logger on a Logger List
	Disconnect	Quickly disconnect from a direct connection
	Cancel COMM OP	Cancel the current communication operation
	Display Real Time Text Values	Selecting this option displays the Instantaneous Channel Values screen
	Retrieve Logger Data	Select this option to quickly retrieve logged data from the connected logger
	Setup PC	Quickly access computer setup configurations
	Create Graph	Create a graph from an open data file, available under the Data dropdown menu
	UnZoom Graph	Use to zoom out of an expanded graph
	Help Topics	Opens the ELITEpro XC Manual

FILE MENU

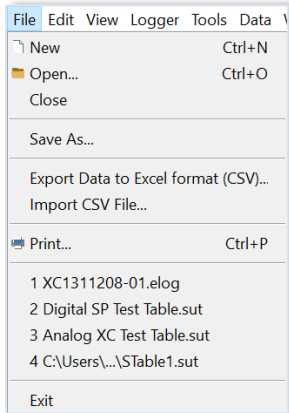

The File menu has options similar to that of other software products, such as a Print Setup and a list of recently accessed files. Descriptions of other options are below:

File > New creates a new file. There are four file types that are available for ELITEpro XC loggers.

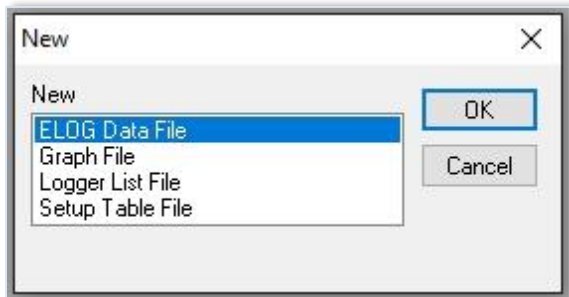

- **ELOG Data File**—contains data retrieved from a logger. If the computer is already connected to a logger, enter the file name for the data about to be retrieved from the logger. If the computer is not connected to a logger, ELOG requests the logger be connected from which the new data file will be extracted.
- **Graph File**—contains graphs created from logger data. Selecting Graph File opens a folder window where you may choose from already existing data files. Choose the one you wish to use to create a graph.
- **Logger List File**—displays groups of loggers used with AutoPoll, an automatic data collection application that is bundled with ELOG. Once chosen, you will be shown the folder where the Logger Lists reside and be allowed to select one for review or editing. (Logger Lists are used by AutoPoll for unattended data retrieval by the computer.)

- **Setup Table File**—If you are not already connected to a logger, ELOG prompts you to select the logger type for which you want to create a new Setup Table. If you are already connected to a logger, ELOG assumes that the Setup Table you are about to create is for the logger type to which you are connected.

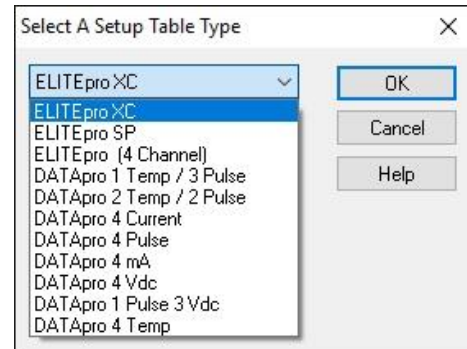

File > Open accesses an existing file, prompting you to select the file type. It operates the same whether or not you are connected to a logger.

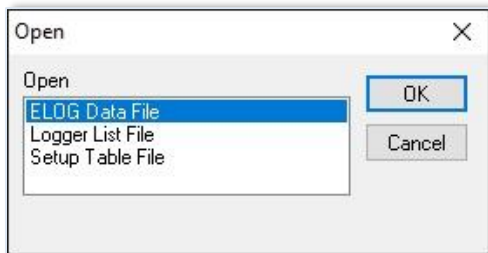

The **File > Save** and **File > Save As** functions allow for the saving of an open file of any type. **Save As** allows for saving to a new location or new name.

The **File > Export Data File** allows you to export a data file to a .csv file for use in another application.

The **File > Import CSV File** allows you to import a .csv file into ELOG.

EDIT MENU

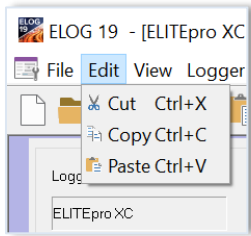

The ELOG Edit Menu has the standard Windows Cut, Copy, and Paste options.

VIEW MENU

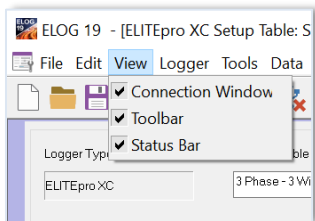

The **View** menu is used to display ELOG features in the ELOG window. Each display may be turned on or off in the window by clicking on the corresponding menu option.

The **Connection Window** appears at the bottom of the screen during connection to a logger and provides information about the logger, communication port, baud rates, etc. Refer to *Communicate with the ELITEpro XC* in Section 1 for more information.

The **Toolbar** option enables/disables the row of ELOG “Speed” buttons under the main menu.

The **Status Bar** option enables/disables information at the bottom of the ELOG window.

LOGGER MENU

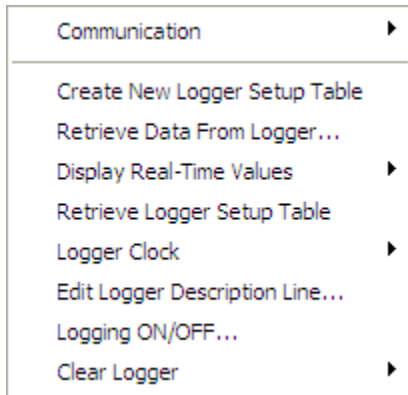

The **Logger** menu is used to configure the ELITEpro XC, view channel data in real time, download logger data, and set communication parameters. Graphing and analysis functions are found under the Data menu.

Communication Sub-Menu

Use the options on the Communication sub-menu to establish a connection between the computer and the ELITEpro XC.

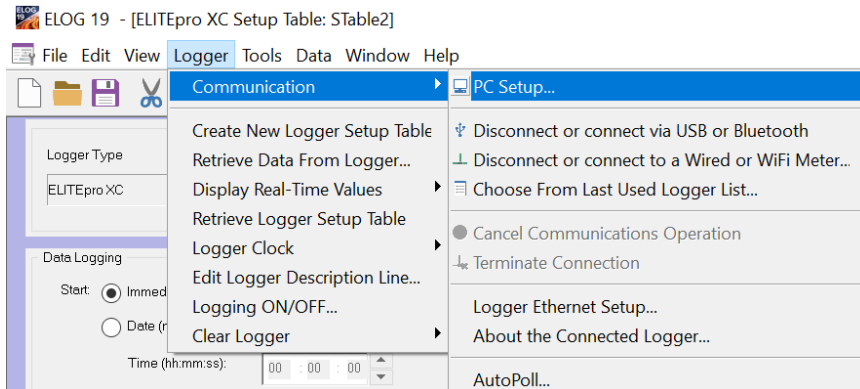

The options on the Communication sub-menu determine how communication with the ELITEpro XC is established and where logger information is saved.

- **PC Setup**

Use this option to set the default location for data, setup tables, and logger files. You can also set the default PC communication ports here. To enable legacy menu items for customers using legacy logger products, select the **Use Legacy Logger interface** checkbox and then choose Save Changes. The ELOG software will only display features and menus relevant to legacy products unless you connect to a new product. See **Tools Menu, PC Setup** for further information.

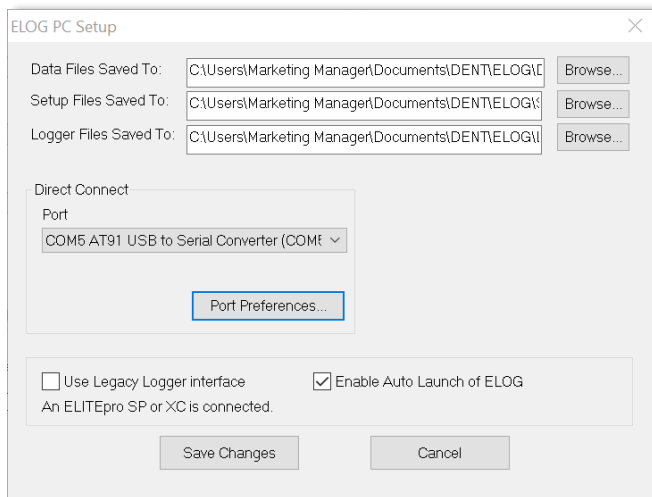

- **Connect via USB or Bluetooth**

This option is used to connect ELOG to a logger via a direct USB cable connection to the PC or with *Bluetooth* wireless technology. A connect message appears on the screen in the Connection window. See **Appendix E—Communication Options**.

- **Connect via Ethernet or Wi-Fi...**

This option is used to connect ELOG to a logger over a network via an Ethernet, Wi-Fi, or Access Point-to-Point Mode connection. See **Appendix E—Communication Options**.

- **Choose From Last Used Logger List...**

Use this option to connect to a logger contained in a recently used logger list.

- **Cancel Communications Operation**

During any communication operation between the computer and the logger (connecting, retrieving data, viewing real time values), this option may be used to cancel the current communication command.

- **Terminate Connection**

Use this option to end the connection between the PC and the logger.

- **Logger Ethernet Setup...**

Enter the IP Address, Local Port Number and, if needed, the Subnet Mask and Gateway Address to connect the logger to a network via an Ethernet cable. This is the same IP address and Port Number you enter in the Network Connect dialog box to connect via Ethernet with ELOG. Select **Update Logger** to send the new Ethernet Setup to the logger or **Cancel** to close the window without updating the logger. See **Appendix F—Detailed Connection Options**.

- **Logger WiFi Setup**

Use this option to set up your Wi-Fi network. Click **Help** to find information on how this setup is used. Select **Update Logger** to send the new Wi-Fi Setup to the logger or **Cancel** to close the window without updating the logger. **Appendix E—Communication Options.**

The screenshot shows the 'Logger WiFi Setup' dialog box. It is divided into several sections: 'Logger' with fields for 'Serial Number' (XC1305219) and 'Description' (DENT ELITEpro.XC); 'Antenna' with radio buttons for 'Use External antenna' and 'Use Internal antenna' (selected); 'WiFi' with 'WiFi Mode' (radio buttons for 'Access Point Mode' and 'WiFi Mode', with 'WiFi Mode' selected), a 'Set WiFi Network Password' button, 'WiFi Network SSID' (DENT), 'IP Address' (192.168.10.1), 'TCP Port' (3001), and radio buttons for '80 (for web/app use)' and '3001 (for ELOG)' (selected); 'Subnet Mask' (255.255.255.1), 'Gateway Address' (10.75.75.254), and 'MAC' (undetermined); and 'IP Address' with radio buttons for 'Use DHCP' and 'Use Static IP' (selected). At the bottom are buttons for 'Help', 'Save...', 'Load...', 'Update Logger', and 'Cancel'.

- **Logger Web Login Password**

Use this option to create a password for accessing your Wi-Fi from the web. **Appendix E—Communication Options.**

The screenshot shows the 'Web / Mobile App Login Password' dialog box. It features a text input field for 'Enter new password:' containing several dots, a 'Hide your typing' checkbox (checked), and 'OK' and 'Cancel' buttons. A text box at the bottom contains the instruction: 'Please enter the password to use when connecting to the logger via web browser or mobile device (up to 31 characters). Leave empty for no password required. What you type will not be masked unless you check the option to hide your typing.'

▪ **About The Connected Logger...**

This option displays a text window containing information about the currently connected logger’s properties, such as logger type, firmware version, description, etc., and information about built-in communication options, if any. Click **Refresh** to retrieve new information (for example, if the number of records used is changing) or **OK** to close the window.

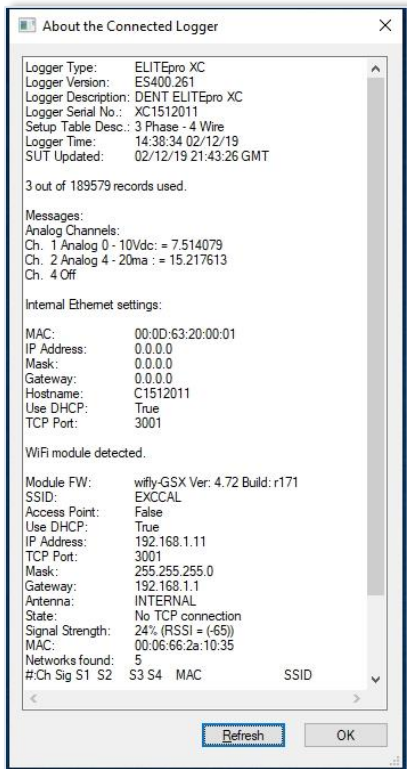

▪ **AutoPoll**

AutoPoll is a standalone Windows program (supplied with ELOG) that may be used for unattended and automatic data retrieval from a number of remote loggers where the PC connects to the loggers. A complete description of AutoPoll can be found in a separate document: **AUTOPOLL: Unattended Data Collection**.

Retrieve Data From Logger

Retrieves data from the logger and saves it as an .elog file on the hard disk. The **Select A Directory And A Name...** dialog box displays prompting you for a file name. The default name is the logger serial number plus two digits that correspond to the number of times that data has been retrieved from the logger, however, at this point you may name the data file whatever you wish.

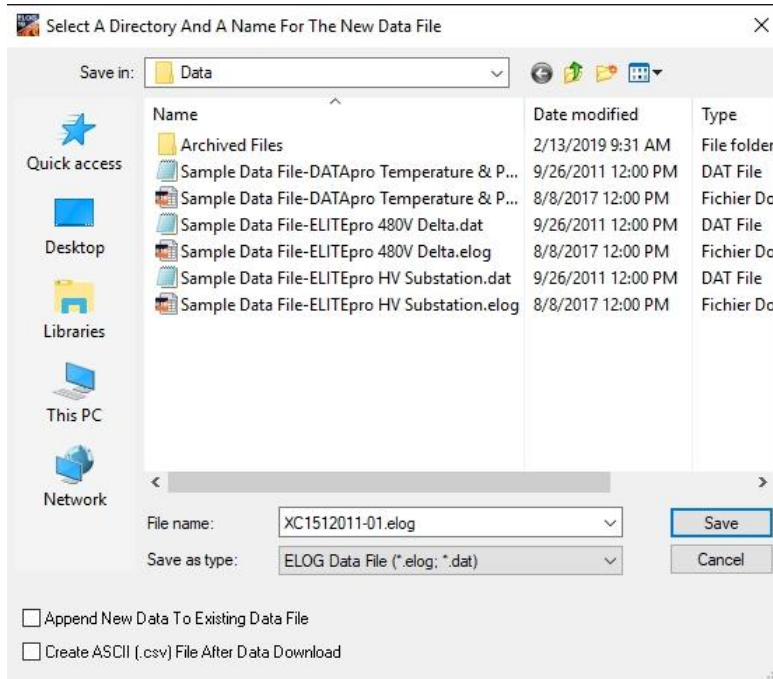

There are two checkboxes in the lower left of the dialog box to select if you want to add (append) the data to an existing file and/or create an ASCII file of the data.

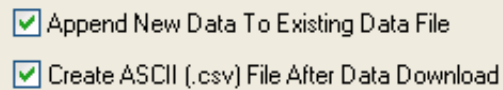

When a logger's memory is downloaded, the data may be added or "appended" to an already existing file from the same logger. Check the **Append New Data To Existing Data File** box. The name of the dialog box changes to **Select a Data File to Append Data To**. Select the file to which you wish to add the data.

The selected file must have used the same Setup Table of the earlier downloaded data. Selecting a file with different Setup Table parameters than those in the logger causes the following warning to display:

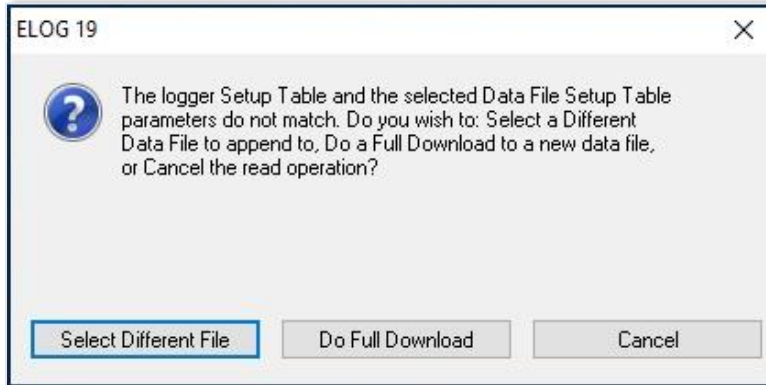

When the data is retrieved, a second comma separated value format (.csv) file can be created at the same time as the .elog data file is being downloaded. A .csv file is also called a “flat file,” or “ASCII file” and can be opened in other applications such as Excel.

The data is saved to the folder specified in **Tools > PC Setup > Data Files Saved To:** unless changed in the **Select a Directory and A Name...** window. The default data folder is C:\Users\UserName\Documents\DENT\ELOG\Data.

To view a data file, use **Data > Open Data File** and then select the desired file.

Even if not downloaded as a .csv file, the original binary .elog data files may at any time be exported to a comma delimited ASCII file with a .csv extension. See the Export Data File section for more information.

Display Real-Time Values Sub-Menu

The Display Real Time Values option shows instantaneous readings for channels in use in either a textual or graphical format. Real-Time Values are an excellent way to verify the correct installation of a meter.

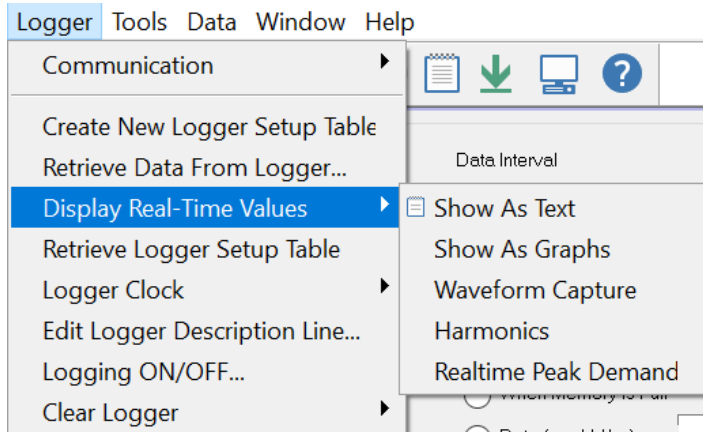

Real-Time Values may be displayed in either a textual or graphical format.

- **Show As Text**

When this option is selected, a screen similar to the one on the following page displays. All channels that are turned on (even if not being recorded) are displayed simultaneously. If a parameter is being recorded by the logger, it will be shaded in green as shown in the Real-Time Channel Values window (see next page). For a Power Channel, all six power parameters (V, A, kW, kVA, PF, and kVAR) are displayed even if only one of the parameters is recorded.

This feature is useful for verifying correct installation of the logger. This screen provides information about:

- The real-time data (which can be paused for cross-channel comparisons)
- The Line Frequency as measured between L1 and L2
- How much memory has been used and how many days the memory has remaining before filling
- The logger clock's current date and time
- Whether or not the data logging is turned on
- Type of memory: Linear (Stop When Full) or Ring (Continuous)

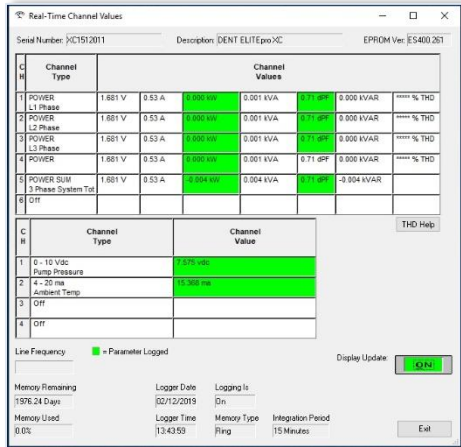

Click **Exit** to close the window.

■ **Show As Graphs**

This menu selection displays the data as a graph instead of the text format described previously.

Select **Logger > Display Real-Time Values > Show as Graphs** to display the following dialog box.

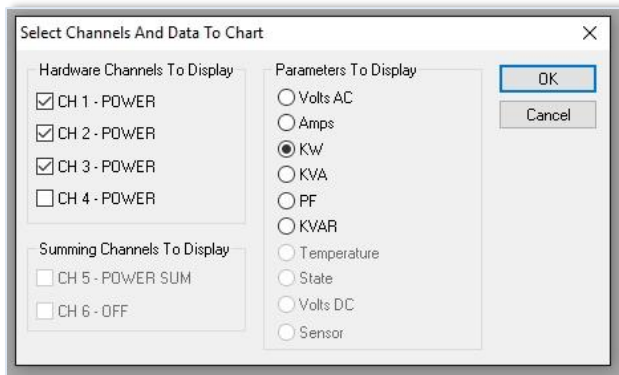

1) Select any or all physical power channels currently turned on in the logger in the **Hardware Channels To Display** section.

-or-

Select one or both calculated power channels currently turned on in the logger in the **Summing Channels To Display** section.

Selecting a power channel activates the **Parameters To Display** option. You can only select one variable at a time to graph. This is not like a text display option where parameters are viewed simultaneously. This is due to differences in scaling and to reduce clutter on the graph. For example, you could display kW from four channels simultaneously but not a kW and a KVAR even if it is from the same channel.

- 2) Select a parameter to chart.
- 3) Select **OK** to view the graph.

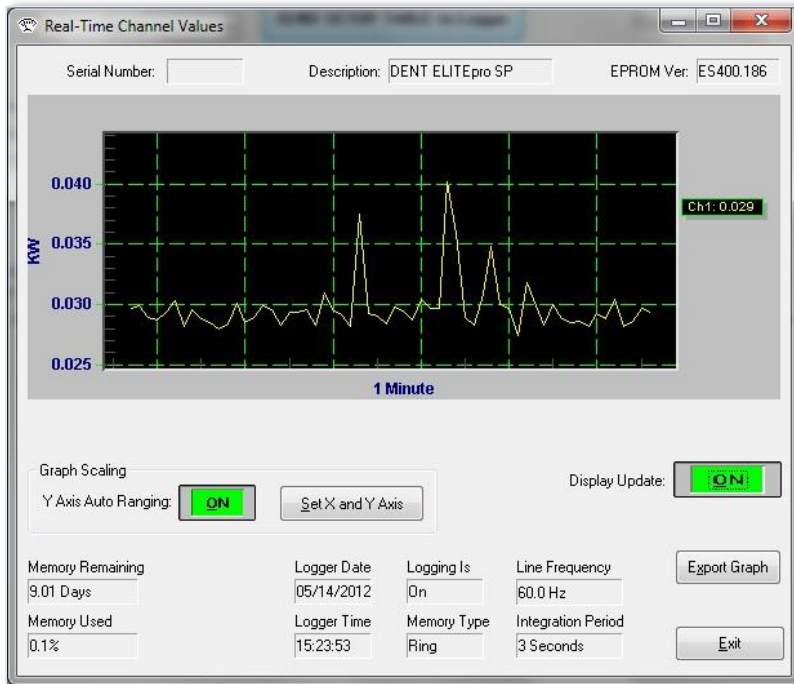

The graph begins on the left edge and moves to the right. When it reaches the right edge, the entire graph scrolls to the left with each new reading. This always displays the most current data values and the older points slide off the left edge.

- Use **Set X and Y Axis** to set the scaling and the line type (e.g., linear or logarithmic). You can also set the amount of time data is graphed. This can vary from 1 second to more than 18 hours (65,000 seconds). Note that the X-axis scaling is only approximate.

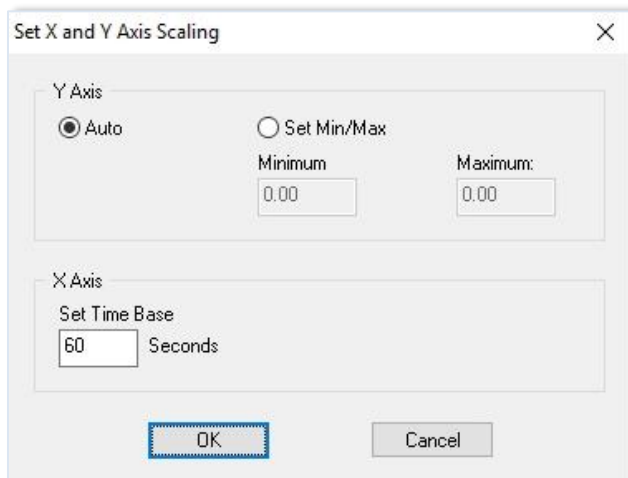

- Use **Export Graph** to save the graph in a graphical or textual format. Graphs can be saved in an .emf, .wmf, .bmp, .jpg (default), or .png format. You can select where the graph goes (clipboard, file, or printer) and what measurements (pixels, millimeters, inches, points) are used to save the graph.

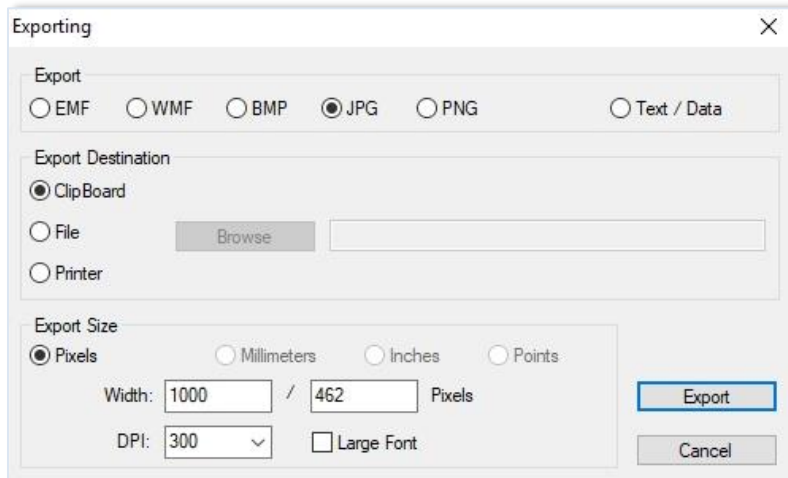

- Waveform Capture**

Select **Logger > Display Real-Time Values > Waveform Capture** to view the actual current, voltage and power waveform. The first capture is, by default, channel 1, but you can select different channels (logging off or on) to view and copy the waveform to the clipboard for pasting into other programs or for printing.

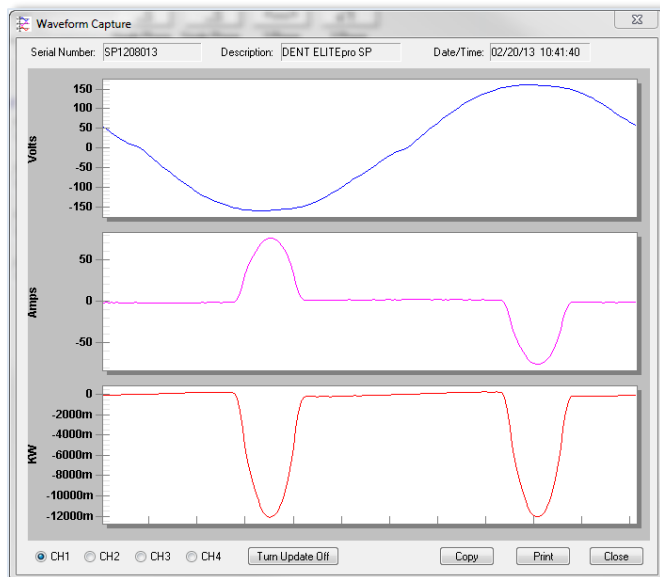

- Harmonics**

Select **Logger > Display Real-Time Values > Harmonics** to see the actual harmonic content in the current, voltage, and power waveforms. A typical display is shown here:

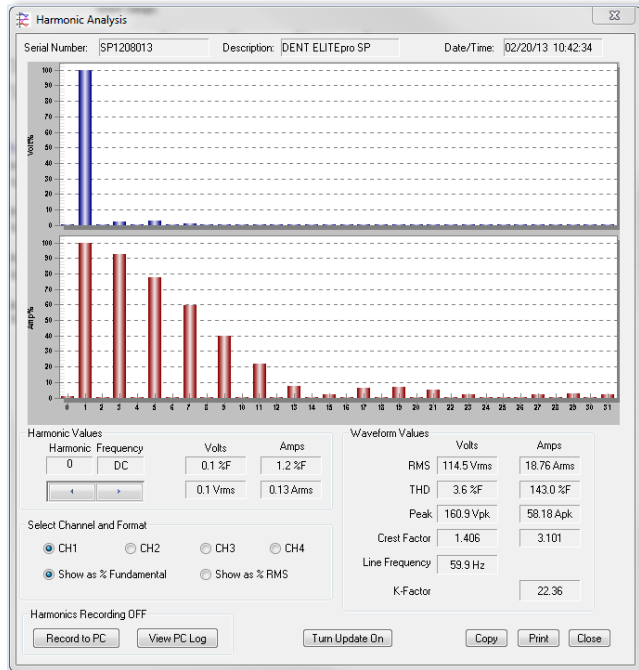

The selections on the lower left side of the window select the displayed Channel. Only one channel may be viewed at a time. The voltage and current harmonics are presented graphically in the upper part of the window. The ordinate (y-axis) is scaled in percent of the fundamental. The abscissa (x-axis) is the harmonic. Both even and odd harmonics plus DC are shown.

The actual value of the voltage and current for each harmonic may be found in the Harmonic Values section. By clicking on the arrow buttons, higher and lower order harmonics may be selected. Though only the first 31 harmonics are displayed in the graph, the Harmonic Values function can be used to view the values up to the 63 harmonics. The Waveform Values section provides summary statistics for the overall voltage and current waveforms. This includes the RMS value, THD, Peak values, Crest Factor, Line Frequency, and K-Factor.



The individual harmonic values and THD can be shown as a percentage of the fundamental (IEEE Standard 1035-1989) or as a percentage of the total RMS value (CSA and IEC standard).

The image in the upper section of the Harmonic Analysis window is a single waveform snapshot. The first image is, by default, Channel 1, but you can select different channels and update the image, copy the image to the clipboard for pasting into other programs, or print the image.

You can also record the harmonic values to your PC and then view a log of the harmonics in a spreadsheet. When you click **Record to PC** the Harmonic Logging Parameters dialog box displays.

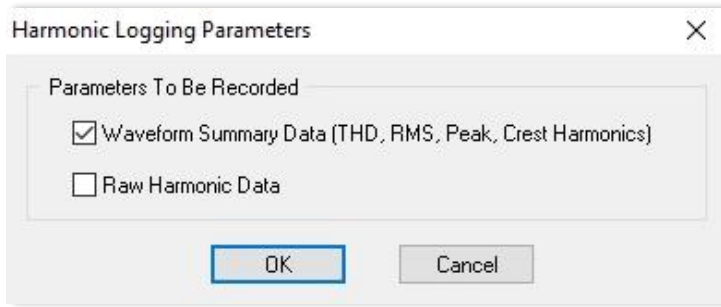

- 1) Select the **Waveform Summary Data** check box to create a “single column” of data in a spreadsheet stored on the PC. The data is the average harmonic content for each harmonic of the first 31 harmonics over the period of time the harmonic data is collected.

Selecting **Raw Harmonic Data** creates a spreadsheet with the information above and a “row” of the 31 harmonics for each update of the logger. Since the logger updates faster than one time per second, selecting this option will create a LOT of data quickly!

- 2) Click **OK** and the recording begins.

The **Record to PC** button now reads **Stop Recording** on the Harmonics Analysis screen. Click that button to stop recording harmonic values to the PC.

- 3) Click **View PC Log** to open a file of recorded harmonic values in a spreadsheet on your computer.

- **Realtime Peak Demand**

When a logger is connected with Power 5 and/or Power 6 Channels on, select **Logger > Display Real-Time Values > Realtime Peak Demand** to request a report showing peak demand and totalizer values directly from the logger instead of from a data file.

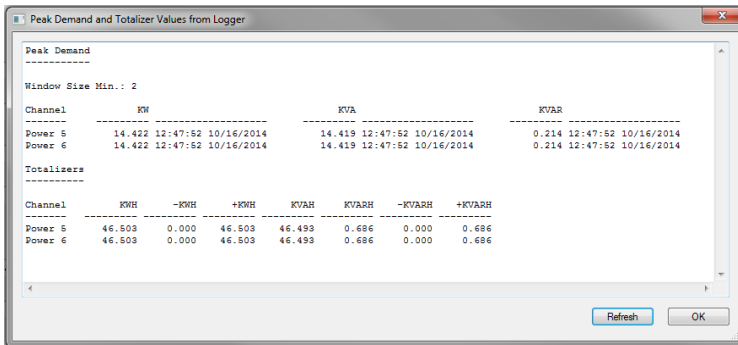

Retrieve Logger Setup Table

This function instantly retrieves the Setup Table in the logger so it can be viewed, edited, resent to the logger, or saved to the hard drive.

Logger Clock Sub-Menu

This function is used to set the logger's internal clock time and date. You may change the clock manually or synchronize it to the computer's clock. Note that the logger clock is actually set to UTC (also known as Greenwich Mean Time). When reading the logger clock or viewing data files, ELOG reads the Windows settings and converts the UTC time stamps in the logger to the local time zone of PC. If two PCs in different time zones retrieve a data file from the logger, or read the logger clock, they will see different times.

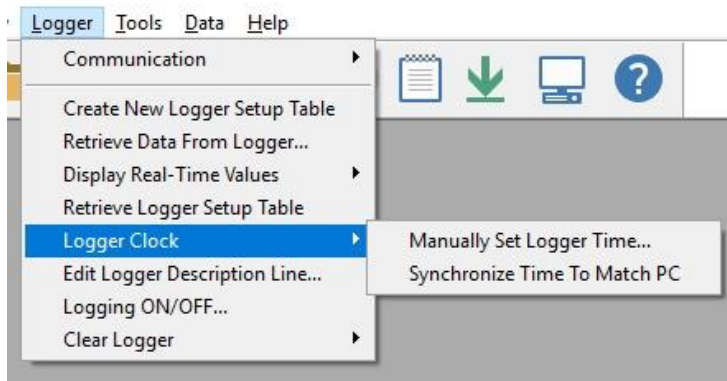

Set the logger's internal clock and date using the following menu option: **Logger > Logger Clock**. You may change the clock manually or synchronize it to the computer's clock.

- **Manually Set Logger Time**

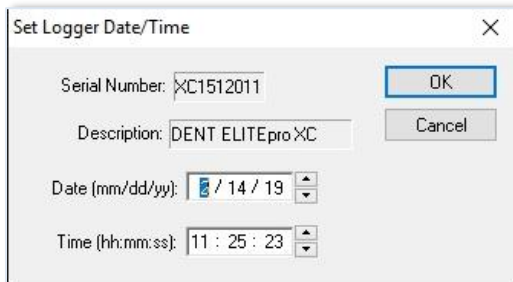

Use this option to manually set the date and internal clock. The date format defaults to what is used by the time settings on your PC (mm/dd/yy or dd/mm/yy) and the clock uses a 24-hour format.

- **Synchronize Time To Match PC**

Use this option to read the computer clock and automatically update the logger.

Edit Logger Description Line

This option allows you to change the user-defined, one-line description stored in the logger. The Description Line can help identify the specific logger after the logger is retrieved from the field.



Logging ON/OFF

This option starts or stops data collection.

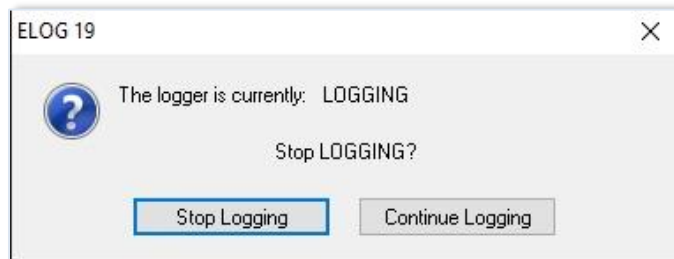

Clear Logger Sub-Menu

There are three options for clearing data stored in the Logger: Clear all logger data, Clear only peak demand values (kW, kVA, & kVAR), or Clear only KWh, KVARh, KVAh, etc., totals. After the data is deleted, it cannot be retrieved.

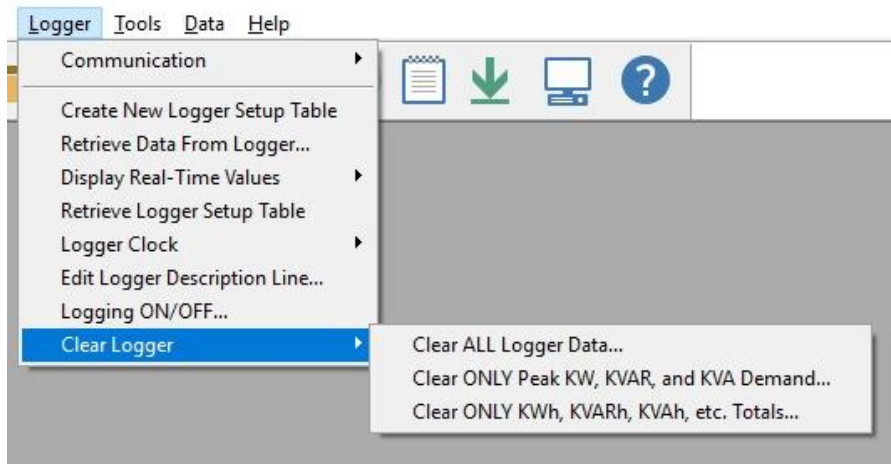

Do not select any options until you are sure that all information should be deleted from the logger.

- **Clear ALL Logger Data**

Clears all data in the logger memory, including Peak Demand and Totals. Once deleted, it cannot be retrieved.

- **Clear ONLY Peak KW, KVAR, and KVA Demand...**

Clears only the peak demand values, kW, kVA, & kVAR. Once deleted, it cannot be retrieved.

- **Clear ONLY KWh, KVARh, KVAh, etc. Totals...**

Clears only cumulative totals. Once deleted, it cannot be retrieved.

TOOLS MENU

The Tools Menu accesses the same PC Setup option available on the Communication sub-menu and also includes options to install logger firmware or restore hidden messages.

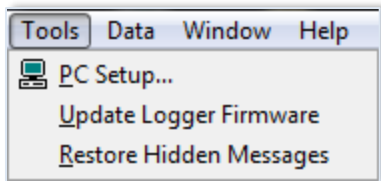

PC Setup

Selecting **Tools > PC Setup** allows you to configure the computer connected to the ELITEpro XC. It is also where you set the default file storage folders.

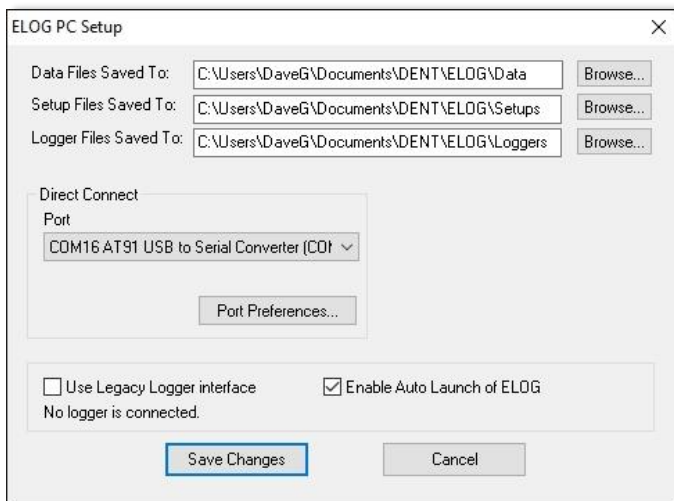

The **Data Files Saved To:** field displays the folder selected for storage. Click **Browse** to set the default folder in which data files are saved. Data files are sent to the specified folder when retrieving data files using the **Logger > Retrieve Data** option.

The **Setup Files Saved To:** sets the default folder in which Setup Tables are saved. ELOG will look in this folder first when opening a Setup Table file.

The **Logger Files Saved To:** sets the default folder in which logger files are saved. ELOG looks in this folder first for the Logger Lists to call when using the AutoPoll automatic data collection application.

The **Direct Connect** section displays the selected USB port and selects the computer's USB port to which the ELITEpro XC is connected.

ELOG is equipped with a feature called **Friendly Ports™**. ELOG displays available Windows COM ports with easy-to-understand device descriptions enabling you to find the appropriate port quickly and easily.

The **Port Preferences** option is used to hide COM Ports from ELOG, to change the order of COM Ports as they appear in the dropdown control, and how they are searched when ELOG can't connect to a logger on the desired port.

Ports that are unchecked will be hidden from ELOG. Ports are listed and searched in the order shown. The order can be changed by selecting a port and moving it up or down.

Every time ELOG connects to a logger, its port is moved to the top of this list.

The **Use Legacy Logger interface** checkbox defaults to unchecked, and the ELOG software will only display features and menu items relevant to the current software and hardware release. Select the checkbox and click **Save Changes** to enable legacy menu items for customers using older legacy products (ELITEpro or DATApro).

The **Enable Auto Launch of ELOG** checkbox defaults to enable the Auto Launcher, which launches ELOG (if not already open) when an ELITEpro SP or ELITEpro XC is connected to a USB port. When not checked, it disables the feature and hides the Auto Launcher icon in the system tray. Connecting a compatible logger to a USB port while ELOG is already running will still result in ELOG connecting to it automatically (if not already connected to another logger).

Update ELITEpro XC Firmware

If you receive a message when attempting to communicate between the ELOG software and the logger stating, "The connected logger has firmware that is older than this version of ELOG supports, and may not operate properly with this version of ELOG" refer to **Appendix A** to update the ELITEpro XC firmware.

Restore Hidden Messages

Use this option to restore the alert messages that have been turned off.

DATA MENU

Data retrieved from an ELITEpro XC can be opened, graphed, exported, or analyzed.

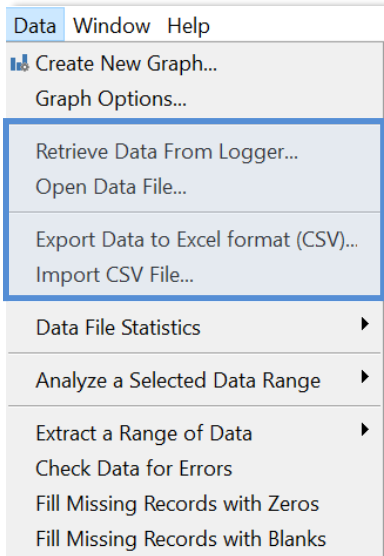

NOTE: These are the only options available on the Data menu when first accessed. The other options appear after a data file is open.

Create New Graph

- 1) When a data file is open, **Data > Create New Graph** displays the *Select Data Types and Ranges* dialog box.

NOTE: Use **Data > Open Data File** to create a graph from an existing file.

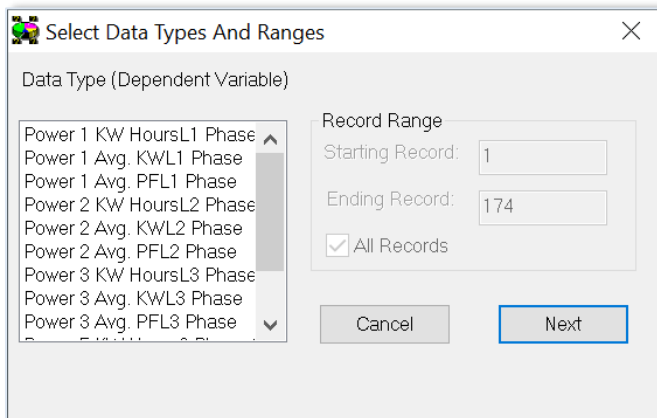

- 2) Left-click the parameters contained in the data file you want to graph. Hold down the Control (Ctrl) key to select multiple parameters, or the Shift key to select a continuous group of parameters.

- 3) Use **Record Range** to define a Starting and Ending range, or select the **All Records** checkbox to display all records available. Options default to All Records, but unchecking the box enables you to set a smaller range.
- 4) Click **Next** to go to the **Set Graph Parameters** dialog window to select the type of graph to create.

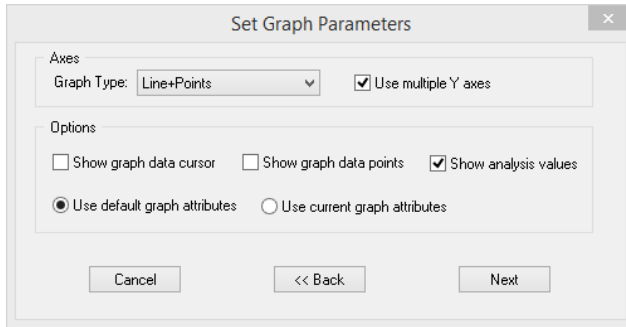

- 5) In the Axes section, select the **Graph Type** in the drop-down menu. You may also choose to select the **Use Multiple Y Axes** checkbox if you have chosen more than one parameter to graph and they have very different ranges (e.g., kW and Power Factor). The option to assign the Y axes is displayed after clicking **Next**.
- 6) In the Under Options section, select the checkboxes for the functions you want to use:
 - **Show graph data cursor**—the data cursor appears when the graph is created (you can also toggle the data cursor on and off with the right mouse button).
 - **Show graph data points**—displays the **Data Point** information above the graph display.
 - **Show analysis values**—shows summary statistics (minimum, maximum, average) on the graph.
 - Use the radio buttons to select one of the following:
 - a) **Use default graph attributes**—uses the default color, font and other graph attributes.
 - b) **Use current graph attributes**—uses the attributes selected for the last graph.
- 7) Click **Next**.

If the **Use multiple Y axes** checkbox was selected the **Select Y-Axis Assignments** window displays in order for you to assign parameters to the Y axes.

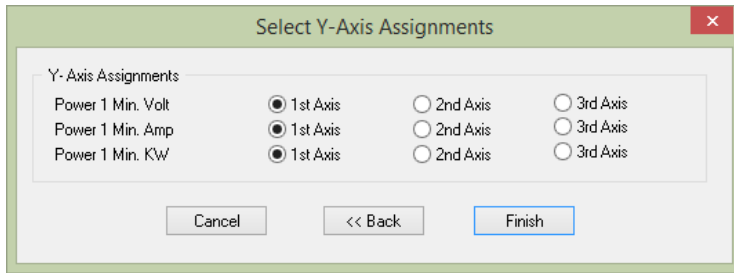

The graph you defined appears similar to the following example. The parameter names to the right are color-coded to match the visual representations on the graph.

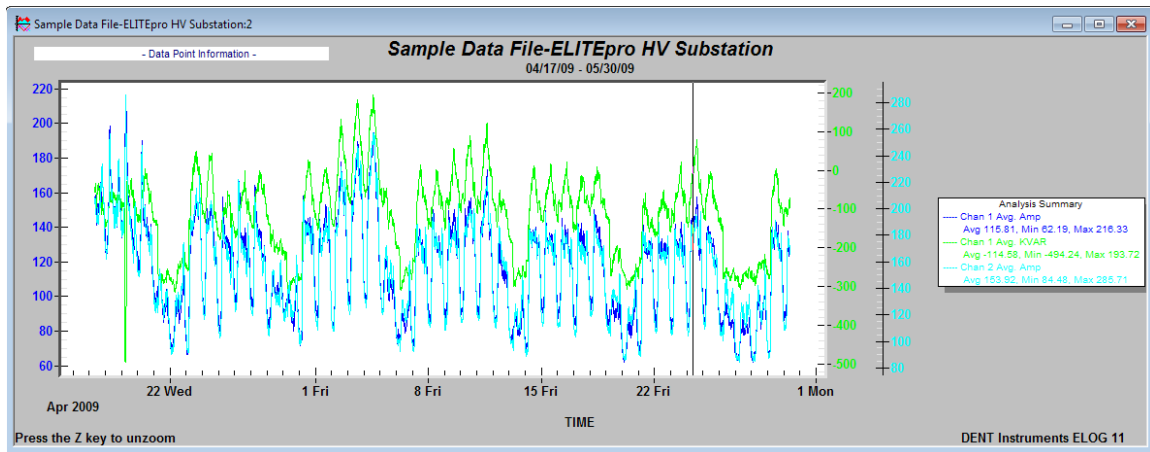

The graph values intersected by the Data Cursor are shown in the upper left-hand corner of the screen.

Once created, the graph may be edited in a number of ways. In general, any editable feature may be changed by double-clicking on the graph and making changes in the dialog box that appears. For example:

- Double-clicking anywhere in the graph area produces a dialog box that gives you various options to customize your graph by changing the graph type, colors, fonts and other options.
- Graphs, as well as other file types (Data, Setup Tables, Logger Lists), may be printed using the **File > Print...** command (or **Ctrl + P**).
- Double-clicking the graph also provides an **Export** option that enables you to export the graph. Choose an option in the **Export** section to choose a graph type. Choose a location to export the graph in the **Export Destination** area. Set the size of the exported graph in the **Export Size** fields.
- Double-clicking the graph also provides a **Maximize** feature that enables you to increase the visual representation of the graph.

Graph Options

The Graph Options dialog box allows you to set several defaults when a new graph is created.

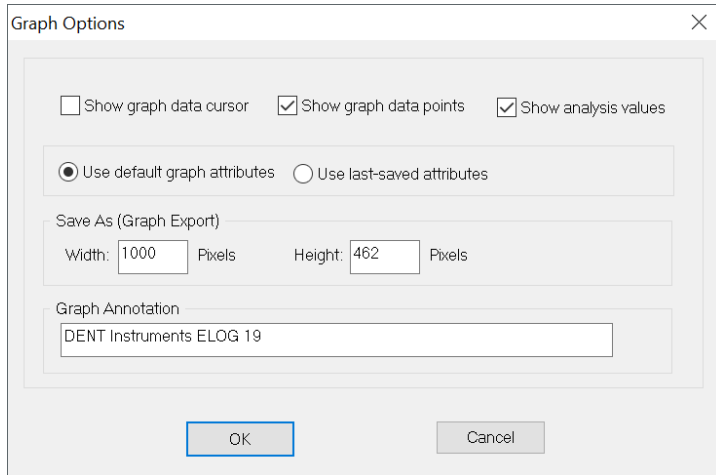

- Select the **Show graph data cursor** check box to turn on the data cursor. The data cursor is a vertical line that appears on a graph and is used to help visually line up multiple graphs. It can also be turned on and off at any time while viewing a graph by right-clicking the mouse button.

If there is more than one variable plotted, all values are shown on the screen. The values are not labeled but are shown in the same order that the variables appear in on the graph.

The data cursor may be moved by using the left-right arrow keys or by using the mouse to left click on the cursor and drag it to the desired location.

NOTE: You will not see the cursor move when using the mouse until releasing the left mouse button.

- Select the **Show graph data points** checkbox to display the specific point at which the data was collected on the graph. It directly correlates to the Data Interval timeframe that was selected in the Setup Table File, e.g. 15 seconds, 5 minutes, 1 hour, etc.
- Select the **Show analysis values** checkbox to display the average, maximum, and minimum value for each parameter plotted on a graph. The values appear to the right of the graph where the graph labels are also shown. If desired, by unchecking the Show analysis values box, the values will not be shown (or printed) on the graph.

- At the creation of a graph, you have the option of using the default graph attributes or the changes that were last made. Select the **Use default graph attributes** or the **Use last-saved attributes** to determine the attributes. The graph attributes include font sizes, background colors, graph colors and numerous others and can be changed on the graph itself by right-clicking. Every time a graph is made, and there is a change to any of the attributes, the changes are remembered by ELOG. Once a graph is made you cannot change the graph attributes using this window. You must change them from the graph itself.
- Use the **Graph Annotation** field to tile the graph. If you make a lot of graphs and want to have the same annotation on the graph, you may use this feature to add a description to the graph. Common uses are the name of the consulting company performing the metering and analysis or the name of the client.

Retrieve Data From Logger

This function is identical to the **Retrieve Data...** command in the **Logger** menu. It is used to download the data from the logger to the computer prior to viewing, graphing, or exporting.

Open Data File

Data files stored on the logger can be viewed (but not edited) by selecting this menu item.

To view a data file, it must first be downloaded from the logger by using this option or the **Logger > Retrieve Data from Logger...** command.

The data is always shown in the same way. The left-most column is the record number and begins with 1 and continues through all of the data records in the file. The second column is the date of the record and the third column is the time of the record.

The fourth and remaining columns are the data recorded by the logger for each parameter. If minimum or maximum values were recorded then the time, to the second, that the maximum or minimum occurred is also recorded.

Export Data File

This exports the raw, binary .elog file to a .csv format (Comma Separated Value) file, which can be brought into a spreadsheet program.

To view the data from a spreadsheet program follow these steps:

- 1) Retrieve the data from the logger using **Logger > Retrieve Data from Logger** or **Data > Open Data File**.
- 2) Select **File > Export Data to Excel Format (CSV)**. The *Select a File for Export* dialog box displays.

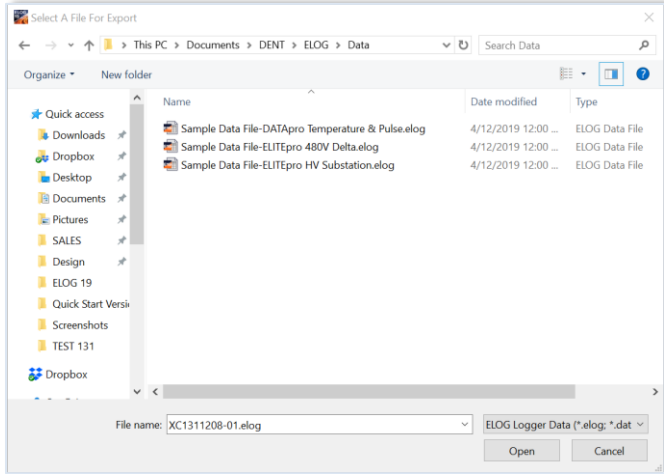

- 3) Select a file and click **Open**. The ELOG File Export dialog box displays when the file data completes exporting to a .csv file format.

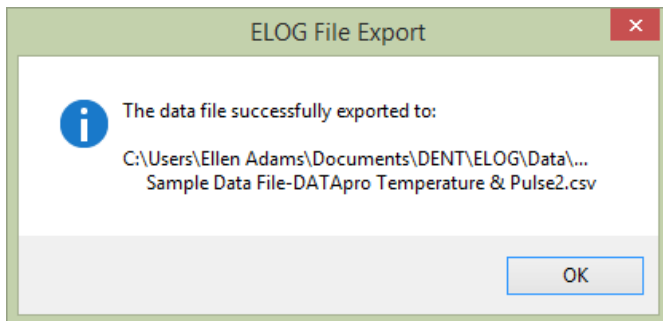

- 4) Start a spreadsheet program such as Excel™.
- 5) Use the **File > Open** command in the spreadsheet and select **All Files** in the *Files of type* drop-down list.
- 6) Open the .csv data file from the folder you specified, for example:
C:\Users\UserName\Documents\DENT\ELOG\Data

Import CSV File

This feature imports a previously saved .csv file into ELOG for use. Select the file you wish to import, and then choose **Open**.

Data File Statistics

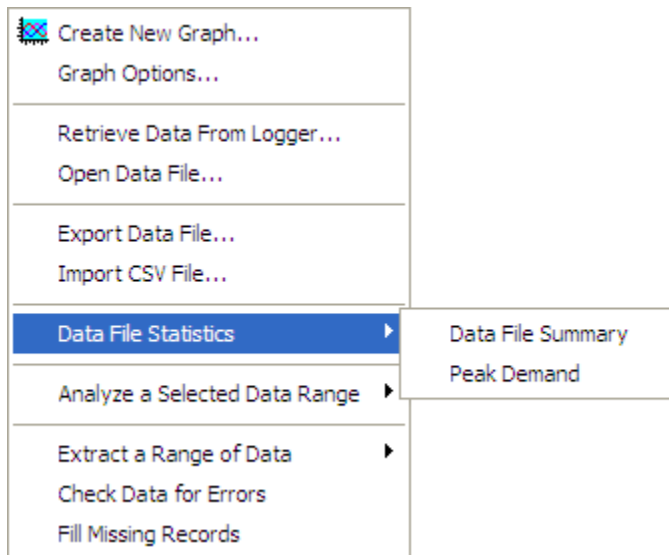

Data File Statistics is a useful feature for viewing a lot of information about the data file and peak demand on the channels. This is where the kWh, kVARh, and kVAh totalizer values are found. An example Summary is shown on the next page.

The sub-menu has two functions:

- **Data File Summary**

Provides the start and end times of the data, file name in the computer, and summary statistics for each channel and parameter that was recorded by the logger. The Data File Summary is opened in Microsoft Notepad™ and can be edited, saved, printed and/or moved into another report.

```

Data Summary
-----
Data File Name: SP1203055-07

First Data Record End Time: 02/08/13 16:30:00
Last Data Record End Time: 02/10/13 09:45:00
Monitoring Period Duration: 1.73 days

Peak Demand
-----

Window Size Min.:      0

Channel  KW          KVA          KVAR
-----  -
Chan 5   off
Chan 6   off

Totalizers
-----
Channel  KWH  -KWH  +KWH  KVAH  KVARH  -KVARH  +KVARH
-----  -
Chan 5   0.000  0.000  0.000  0.000  0.000  0.000  0.000
Chan 6   0.000  0.000  0.000  0.000  0.000  0.000  0.000

Channel  Average  Maximum (Date Time)  Minimum (Date Time)  Total
-----  -
Chan 1 Avg. KW  0.000  0.000 (02/10/13 09:45:00)  0.000 (02/10/13 09:45:00)
Chan 1 Avg. PF  1.000  1.00 (02/10/13 09:45:00)  1.00 (02/10/13 09:45:00)
Chan 2 Avg. KW  0.000  0.000 (02/10/13 09:45:00)  0.000 (02/10/13 09:45:00)
Chan 2 Avg. PF  1.000  1.00 (02/10/13 09:45:00)  1.00 (02/10/13 09:45:00)
Chan 3 Avg. KW  0.000  0.000 (02/10/13 09:45:00)  0.000 (02/10/13 09:45:00)
Chan 5 Max. Volt  0.0  0.0 (02/10/13 09:45:00)  0.0 (02/10/13 09:45:00)
Chan 5 Avg. Volt  0.0  0.0 (02/10/13 09:45:00)  0.0 (02/10/13 09:45:00)
Chan 5 Amp Hours  0.00  0.00 (02/10/13 09:45:00)  0.00 (02/10/13 09:45:00)  0.00
Chan 5 Min. Amp  0.00  0.00 (02/10/13 09:45:00)  0.00 (02/10/13 09:45:00)
Chan 5 Max. Amp  0.00  0.00 (02/10/13 09:45:00)  0.00 (02/10/13 09:45:00)
Chan 5 Avg. Amp  0.00  0.00 (02/10/13 09:45:00)  0.00 (02/10/13 09:45:00)
Chan 5 Avg. KW  0.000  0.000 (02/10/13 09:45:00)  0.000 (02/10/13 09:45:00)
Chan 5 kVA Hours  0.000  0.000 (02/10/13 09:45:00)  0.000 (02/10/13 09:45:00)  0.000
Chan 5 Min. KVA  0.000  0.000 (02/10/13 09:45:00)  0.000 (02/10/13 09:45:00)
Chan 5 Max. KVA  0.000  0.000 (02/10/13 09:45:00)  0.000 (02/10/13 09:45:00)
Chan 5 Avg. KVA  0.000  0.000 (02/10/13 09:45:00)  0.000 (02/10/13 09:45:00)
Chan 5 Avg. PF  1.000  1.00 (02/10/13 09:45:00)  1.00 (02/10/13 09:45:00)
Chan 5 Min. KVAR  0.000  0.000 (02/10/13 09:45:00)  0.000 (02/10/13 09:45:00)
Chan 5 Max. KVAR  0.000  0.000 (02/10/13 09:45:00)  0.000 (02/10/13 09:45:00)
Chan 6 Min. Volt  0.0  0.0 (02/10/13 09:45:00)  0.0 (02/10/13 09:45:00)
Chan 6 Avg. Volt  0.0  0.0 (02/10/13 09:45:00)  0.0 (02/10/13 09:45:00)
Chan 6 Min. Amp  0.00  0.00 (02/10/13 09:45:00)  0.00 (02/10/13 09:45:00)
Chan 6 Avg. Amp  0.00  0.00 (02/10/13 09:45:00)  0.00 (02/10/13 09:45:00)
Chan 6 Max. KW  0.000  0.000 (02/10/13 09:45:00)  0.000 (02/10/13 09:45:00)
Chan 6 Avg. KW  0.000  0.000 (02/10/13 09:45:00)  0.000 (02/10/13 09:45:00)
Chan 6 kVA Hours  0.000  0.000 (02/10/13 09:45:00)  0.000 (02/10/13 09:45:00)  0.000
Chan 6 Max. KVA  0.000  0.000 (02/10/13 09:45:00)  0.000 (02/10/13 09:45:00)
Chan 6 Avg. KVA  0.000  0.000 (02/10/13 09:45:00)  0.000 (02/10/13 09:45:00)
Chan 6 Min. PF  1.000  1.00 (02/10/13 09:45:00)  1.00 (02/10/13 09:45:00)
Chan 6 Avg. PF  1.000  1.00 (02/10/13 09:45:00)  1.00 (02/10/13 09:45:00)
Chan 6 Min. KVAR  0.000  0.000 (02/10/13 09:45:00)  0.000 (02/10/13 09:45:00)
Chan 6 Avg. KVAR  0.000  0.000 (02/10/13 09:45:00)  0.000 (02/10/13 09:45:00)

Setup Summary
-----
Setup Table Description: 1 Phase - 3 Wire

Channel 1 - Power: VHI: L1, VLO: N; PT = 1.000; CT = 100.000; Phase Shift = 1.100
Channel 2 - Power: VHI: L2, VLO: N; PT = 1.000; CT = 100.000; Phase Shift = 1.100
Channel 3 - Power: VHI: N, VLO: L1; PT = 1.000; CT = 100.000; Phase Shift = 1.100
Channel 5 - Power Sum: 1,2
Channel 6 - Power Sum: 1,2,3

Memory Type: Ring
Line Frequency: 60 Hz
Integration Period: 15 Minutes

Logger Summary
-----
Logger Description Line: DENT ELITEpro SP
Logger Serial Number: SP1203055
Logger Type: ELITEpro SP
Firmware Version
ES400.210
    
```

Example of a Data Summary

- Peak Demand**

Provides a report of peak demand information on the channels used for collecting the data. The Peak Demand report is opened in Microsoft Notepad™ and can be edited, saved, printed and/or moved into another report.



Calculations for peak demand are only available when Channels 5 and 6 are on.

Analyze a Selected Data Range

ELOG has a number of analysis features. With a data file open:



The analysis features **only work on one variable at a time**. A variable may be selected in several ways using standard Windows™ methods.

- 1) To select an entire column of data, place the mouse pointer over the column header (e.g., Chan 1 Avg. Amp) and click the left button. The entire column is selected.
- 2) To select a portion of a column, place the mouse pointer over the first record to be included then push the left button down and hold it while dragging the mouse down the screen. When located over the last record to be included, release the mouse button.
- 3) After selecting a data range, click **Data > Analyze a Selected Data Range** and choose the desired Analysis Functions.

A Sample Data File window displays.

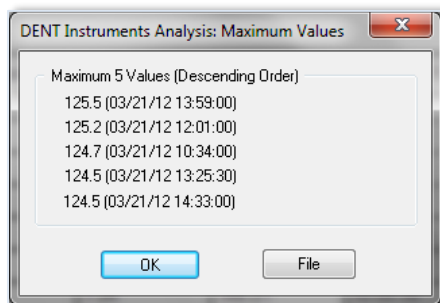

In this example, Maximum Value was chosen. Note that when maximum and minimum are selected, the date and time of the five (5) greatest maxima (or minima) are also shown along with the value.

- 4) Click **OK** to close the window.

-or-

Click **File** to open Windows Notepad™. The maximum value and time of occurrence is shown with the date range for the data selected for analysis. As with the Data File Summary, the data contained in the Notepad file may be edited, saved, printed or moved into another program for report generation.

Each time an analysis function is used and File is selected, Notepad is opened and the result of the analysis function is *added* to the existing Notepad file.

For the first five analysis functions, **Average** is the arithmetic average of all the values in the selected column within the date range of data selected. **Load Factor** is the ratio of the peak (maximum) value divided by the average value. **Maximum** and **Minimum** are the largest and smallest values together with the day and time of the occurrence. **Total** is the algebraic sum of all the values (useful for summing kWh within a specified period of time).

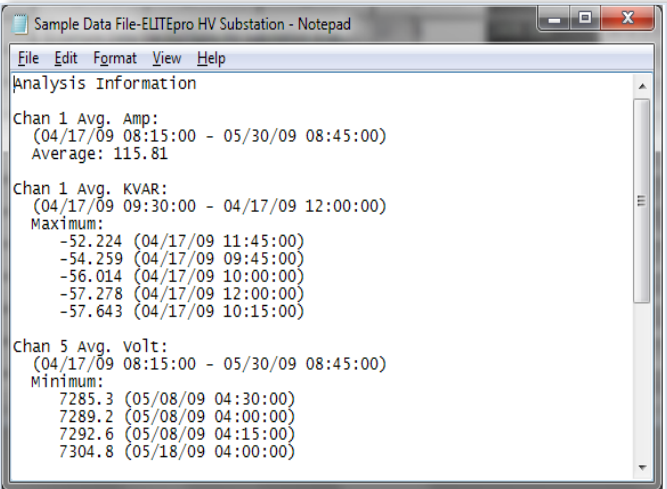

```
Sample Data File-ELITEpro HV Substation - Notepad
File Edit Format View Help
Analysis Information
Chan 1 Avg. Amp:
(04/17/09 08:15:00 - 05/30/09 08:45:00)
Average: 115.81
Chan 1 Avg. KVAR:
(04/17/09 09:30:00 - 04/17/09 12:00:00)
Maximum:
-52.224 (04/17/09 11:45:00)
-54.259 (04/17/09 09:45:00)
-56.014 (04/17/09 10:00:00)
-57.278 (04/17/09 12:00:00)
-57.643 (04/17/09 10:15:00)
Chan 5 Avg. Volt:
(04/17/09 08:15:00 - 05/30/09 08:45:00)
Minimum:
7285.3 (05/08/09 04:30:00)
7289.2 (05/08/09 04:00:00)
7292.6 (05/08/09 04:15:00)
7304.8 (05/18/09 04:00:00)
```

5) Select **Graph** to create a quick line graph for any selected variable and range.

-OR-

Select **Daily Profile Graph** to create a composite average daily profile list of the average data values computed by ELOG.

Extract a Range of Data

Users may choose options from this sub-menu to display data from a specified range if all data points collected aren't needed for analysis.

- **Extract By Date**

This option provides the beginning and end date and times of the data file. Choose new endpoints to trim off unwanted data at the beginning or end of the file. Click **Ok** to display the selected range.

- **Extract By Record Number**

This option provides a File Record Range with the option of choosing a set of records based on the record number (first column in the data file). Click **Ok** to create the selected range.



All analysis features in the Analyze a Selected Data Range and Extract drop-down menus can be quickly accessed using the right mouse button.

Check Data for Errors

Use this command to check the data shown for gaps or overlaps in the time sequence, or timestamp errors.

Fill Missing Records with Zeros

"Fill Missing Records with Zeros" detects gaps in the time sequence of the data shown and fills the missing records with 0 values. This feature is useful when data logging has paused (such as during a power outage) and there are gaps in the time stamp records.

Fill missing Records with Blanks

"Fill Missing Records with Blanks" detects gaps in the time sequence of the data shown and fills the missing records with empty records (blank rows). This feature can be helpful to accurately represent power outages in a graph or if you wish to obtain an average value without skewing the result by adding zeros.

APPENDICES

Appendix A—Installing Firmware Updates

Firmware is software that is used as the control program for the microprocessor in your ELITEpro XC. Firmware updates provide new features and bug fixes for the ELITEpro XC. Contact DENT Instruments for more information.

FIRMWARE UPDATES

You can check the firmware version of your ELITEpro XC from the Tools menu. Select **Tools > Update Logger Firmware**. The Firmware Update dialog box displays. No update is required if your firmware File version and Logger Version are the same.

Downloading and Installing Firmware

To install firmware/updates:

- 1) Select **Tools > Update Logger Firmware**. The following dialog box displays:

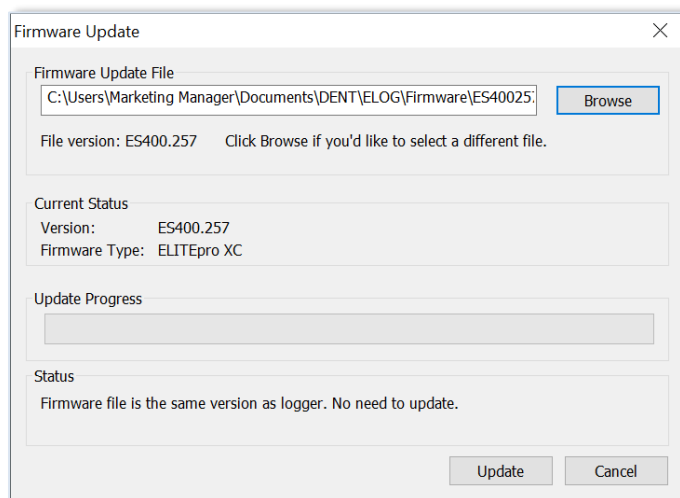

- 2) If necessary, click the **Browse** button to locate the firmware update file.
- 3) Click **Update**.
- 4) The Update Progress bar displays the progress of the firmware update.

Appendix B—Unusual Metering Systems

3-PHASE DELTA WITH A “WILD” (RED) LEG

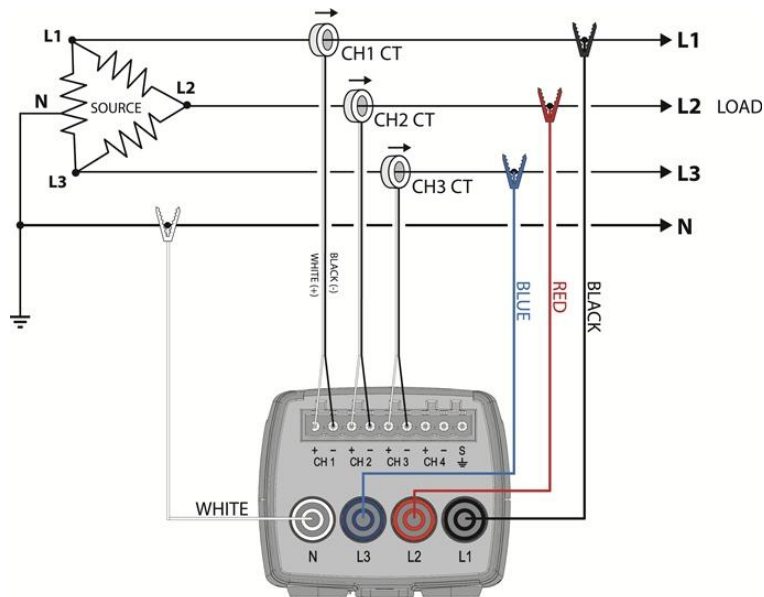

3 Phase DELTA with a “Wild” (Red) Leg

Configure the Setup Table as follows:

Channel	Name	V High	V Low	PT Ratio	Type	Amps	Phase Shift
Channel 1	3 Phase 4 Wire L1-N	L1	N	1.000	MilliVolt	100.000	1.100
Channel 2	3 Phase 4 Wire L2-N	L2	N	1.000	MilliVolt	100.000	1.100
Channel 3	3 Phase 4 Wire L3-N	L3	N	1.000	MilliVolt	100.000	1.100
Channel 4	Off						

Calculated Power Channels	
Channel 5	3 Phase System Total
Power Sum	Combine Channels
	<input checked="" type="checkbox"/> 1 <input checked="" type="checkbox"/> 2 <input checked="" type="checkbox"/> 3 <input type="checkbox"/> 4

2-½ ELEMENT METERS

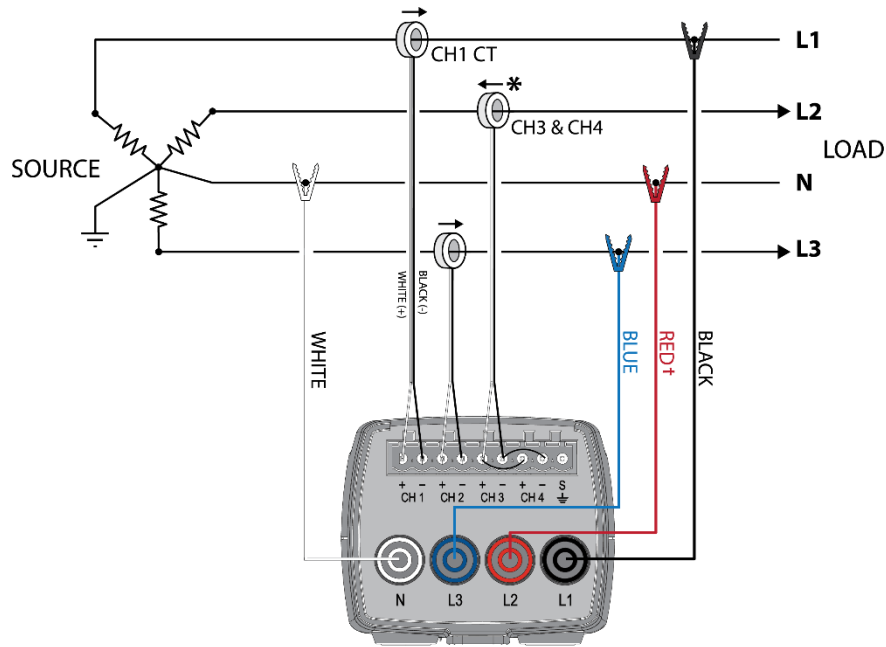

2-½ Element Meters

Configure the Setup Table as follows:

Channel	Name	V High	V Low	PT Ratio	Type	Amps	Phase Shift
Channel 1	L1 CT	L1	N	1.**	MilliVolt	***	1.100
Channel 2	L3 (Not L2!) CT	L3	N	1.**	MilliVolt	***	1.100
Channel 3	L2 CT Reversed*	L3	N	1.**	MilliVolt	***	1.100
Channel 4	L2 CT Reversed*	L1	N	1.**	MilliVolt	***	1.100
Calculated Power Channels							
Channel 5	2 1/2 Element Total	<input checked="" type="checkbox"/> 1 <input checked="" type="checkbox"/> 2 <input checked="" type="checkbox"/> 3 <input checked="" type="checkbox"/> 4					

*The CT on channel three of the **ELITEpro XC** is placed on the L2 phase and is backwards. Note that the Ch3 CT is jumpered in parallel into Ch4 of the logger, and the red L2 wire is used to power the ELITEpro XC.

**Since the 2 ½ Element method is often used on high voltage metering, a PT ratio other than one is typical and should be set to whatever the actual PT ratio is.

***Set the CT value that is true for the CT connected to the ELITEpro XC. Again, because the 2 ½ element method is most often used in high voltage applications, there will be high voltage CTs present. Use a revenue-grade CT, such as the CT-SRS-0005-U from DENT Instruments, on the existing high voltage CT secondary. The CT value used in the Setup Table should be the primary rating of the high voltage CT (assuming the secondary output is 5A).

† The L2 to Neutral connection is required to power the ELITEpro XC.

USING THE 2-WATT ELEMENT (2 CT) METHOD ON A 3-WIRE DELTA SERVICE

Blondel’s Theorem states that the number of watt elements (CTs) needed to monitor a system is one less than the number of wires in the system. This means that a 3-Wire Delta service, even though three phase, requires only two CTs to meter it as there are only three current carrying conductors. The ELITEpro XC uses the 3 CT method for monitoring Delta services as a default because the data is easier to interpret. However, if it is required to use only 2 CTs on a Delta such as when it is desirable to use one ELITEpro XC to monitor two Delta connect loads simultaneously (such as two motors), connect the meter as shown below.

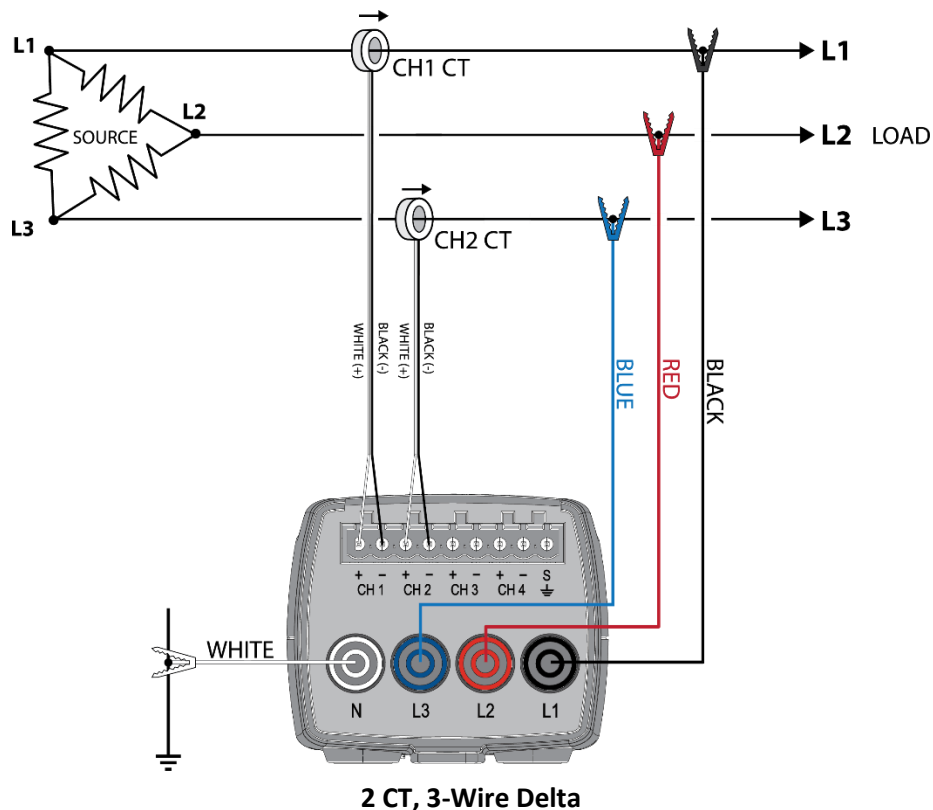

Configure the Setup Table as follows:

Physical Power Channels		Voltage References			Current Transformers		
Power	Name	V High	V Low	PT Ratio	Type	Amps	Phase Shift
Power 1 Power	L1 Phase	L1	L2	1.000	MilliVolt	100.000	1.100
Power 2 Power	L2 Phase	L3	L2	1.000	MilliVolt	100.000	1.100
Power 3 Off							
Power 4 Off							

Calculated Power Channels		Combine Channels			
Power	Name	1	2	3	4
Power 5 Power Sum	3 Phase System Total	<input checked="" type="checkbox"/>	<input checked="" type="checkbox"/>	<input type="checkbox"/>	<input type="checkbox"/>

USING THE 3-WATT ELEMENT (3 CT) METHOD ON A 3-WIRE DELTA SERVICE

Using the two-watt element method on 3-phase 3-wire Delta services is a perfectly valid measurement technique. The 2-element method also uses less logger memory and hardware channels and allows measuring two Delta (3-wire) loads simultaneously. However, we recommend using the 3-watt element method because the 3-element method is more intuitive. By placing a CT on each phase wire, it is easier to understand what is happening in each phase without referring to phasor diagrams.

In 2-element measurements, System VA is calculated from Watts and VARs using the power triangle. In 3-element measurements, System VA is calculated as the sum of the VAs from the individual phases. Both methods are completely valid.

The major difference is how harmonics are treated. When harmonics exist, they are usually only (or mostly) present in the current and not in the voltage. Because watts and VARs are calculated as the instantaneous product of volts and amps, and because an existing third or fifth harmonic current does not have a corresponding voltage harmonic, then the harmonics' products are zero. Therefore, the instantaneous product of volts and amps used to obtain watts and VARs does not include any harmonic component. Thus, the 2-element method does not include any harmonic content in the calculation of System VA. In 3-element systems, because System VA is calculated as the sum of the phase VAs, which in turn are the product of the RMS volts multiplied by the RMS amps, then harmonics are included (in the RMS amps).

There are two methods to calculate Power Factor. One is Apparent Power Factor $PF=W/VA$ where $VA=Volts \times Amps$ and VA would contain harmonic content. The other is Displacement Power Factor that uses the Power triangle $PF=W/\sqrt{W^2 + VAR^2}$ which does not contain harmonic content. The ELITEpro XC displays and records displacement Power Factor.

If there are no harmonics present, the displacement power factor and harmonic power factor are identical. If harmonics are present, the harmonic power factor (3 element) will always be smaller than the displacement 100 power factor (2-element). Similarly, the 3-element VA will always be larger than the 2-element VA. When comparing the ELITEpro XC three-phase measurements with other meters, make sure that the same method of calculating VA and Power Factor is used.

Connecting the ELITEpro XC to a 3-phase 3-wire Delta load using the 3 element method:

It is very similar to the 3-phase, 4-wire WYE connection. Use a CT on each phase and connect the three ELITEpro XC voltage wires to each phase. The neutral wire should then be connected to earth ground. The Setup table should look just like that of the 4-wire WYE setup. See *ELOG Quick Setup Wiring Diagrams* in Section II.

Appendix C—Troubleshooting ELITEpro XC Driver Installation

If you have connected the ELITEpro XC to a computer via the USB cable and the driver fails to install, follow these steps to correct the problem.

- 1) Go to the **Device Manager** by typing “device manager” into the search box in the Windows Taskbar. Or, right-click on the Windows Start Button and select **Device Manager** from the list.

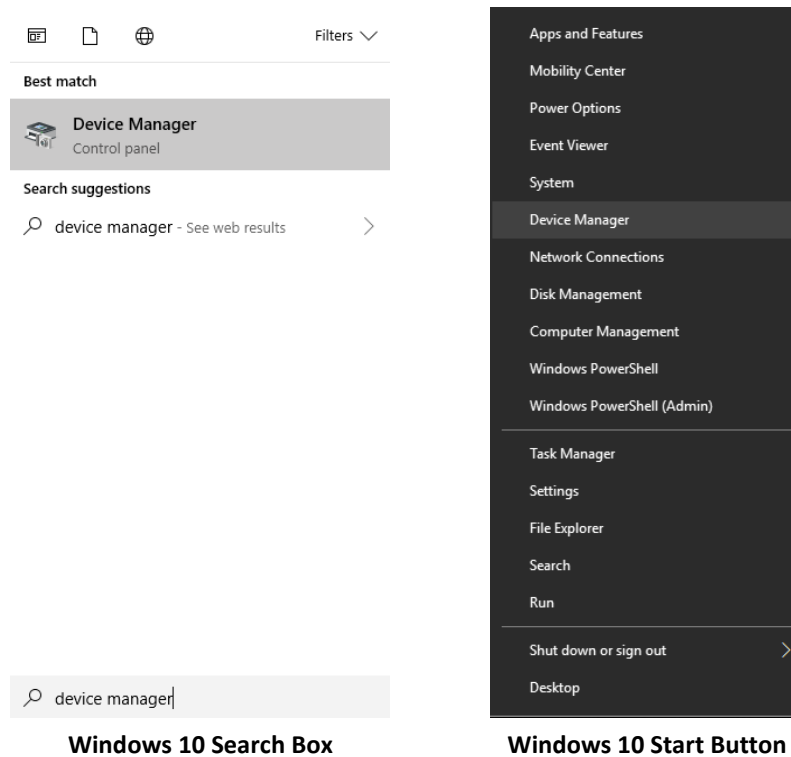

- 2) Once in the Device Manager, look for **Ports (COM & LPT)** in the list. Click the arrow (>) next to **Ports** and find either **ELITEproSP** or **AT91 USB to Serial Converter**.

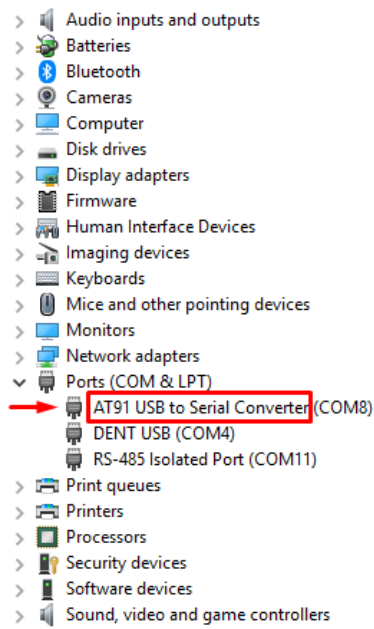

3) Right-click the **ELITEpro XC** and select **Update Driver...**

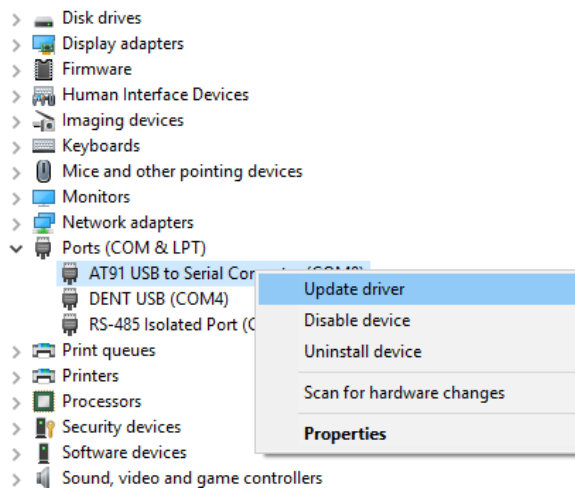

4) Select *Browse my computer for driver software*.

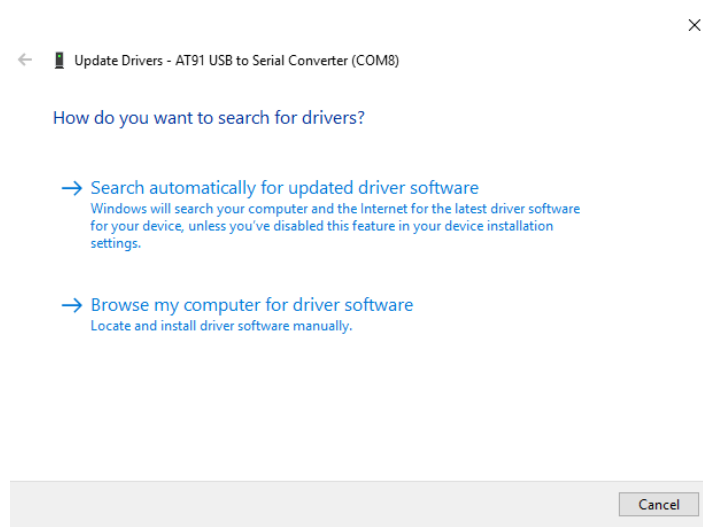

- 5) In the next window, select **Search for driver software in this location:** and Include Subfolders in the search. Click **Browse** and locate the **ELITEpro XC** driver folder in the ELOG directory.
- 6) Click **Next** and the ELITEpro XC driver will install. In the event that you receive a warning dialog box from Microsoft, click **Continue** to proceed.
- 7) Unplug the ELITEpro XC and plug it back in. ELOG should launch and automatically connect to the ELITEpro XC.

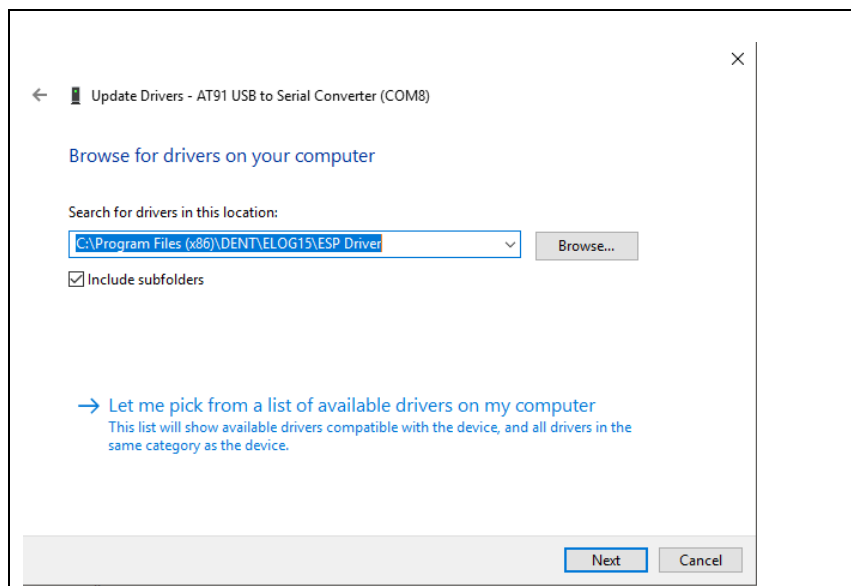

Appendix D—Calculated Power Channel Formulas

The following information details the formulas used to calculate the parameters available in the Power Sum Channels 5 and 6.

WYE CONFIGURATION L1-N, L2-N, L3-N

Measurement	Formula	Notes/Description
Amps (System)	$\frac{L1 + L2 + L3}{3}$	Average of L1, L2, and L3 amp values.
Volts (System)	$\frac{\text{Sum of three phase to neutral voltages}}{3}$	For a Phase to Neutral with WYE configured meter. Average of the three phase-to-neutral voltages.
kW (System)	$L1 \text{ kW} + L2 \text{ kW} + L3 \text{ kW}$	Sum of L1, L2, and L3 phase watt values.
kWh (System)	$\frac{L1 \text{ kW} + L2 \text{ kW} + L3 \text{ kW}}{\# \text{ of samples in an hour}}$	Calculated per waveform sample with a running total of each waveform kWh for the integration period.
VAR (System)	$L1 \text{ kVAR} + L2 \text{ kVAR} + L3 \text{ kVAR}$	
VARh (System)	$\frac{L1 \text{ kVAR} + L2 \text{ kVAR} + L3 \text{ kVAR}}{\# \text{ of samples in an hour}}$	See kWh (System) WYE notes.
VA (System)	$L1 \text{ kVA} + L2 \text{ kVA} + L3 \text{ kVA}$	
VAh (System)	$\frac{L1 \text{ kVA} + L2 \text{ kVA} + L3 \text{ kVA}}{\# \text{ of samples in an hour}}$	See kWh (System) WYE notes.
Apparent PF System	$\frac{\text{kW System}}{\text{kVA System}}$	Measurement calculation information is provided for reference only.
Displacement PF System	$\frac{\text{kW System}}{\sqrt{(\text{kW System})^2 + (\text{kVAR System})^2}}$	

DELTA CONFIGURATION: L1-L2 AND L3-L2

The following formulas apply when using the 2 CT method. When using the 3 CT method on a Delta service the channel 5 and 6 Power Sum equations are the same as for the WYE configuration shown above.

Measurement	Formula	Notes/Description
Amps (System)	$\frac{L1 + L3}{2}$	Average of L1 and L3 amp values.
System Volts (Phase to Phase with DELTA configured meter)	$\frac{(L1 - L2) + (L3 - L2)}{2}$	Average of L1- L2 and L3 – L2 phase to phase voltages
kW (System)	$L1 kW + L3 kW$	Sum of kW L1 and kW L3 phase watt values.
kWh (System)	$\frac{L1 kW + L3 kW}{\# \text{ of samples in an hour}}$	See kWh (System) WYE notes.
kVAR (System)	$L1 kVAR + L3 kVAR$	
kVARh (System)	$\frac{L1 kVAR + L3 kVAR}{\# \text{ of samples in an hour}}$	See kWh (System) WYE notes.
kVA (System)	$\sqrt{(System kW)^2 + (System kVAR)^2}$	
kVAh (System)	$\frac{\sqrt{(System kW)^2 + (System kVAR)^2}}{\# \text{ of samples in an hour}}$	
Apparent PF System		Same as Displacement PF System below. Cannot calculate APF for delta loads.
Displacement PF System	$\frac{kW System}{\sqrt{(kW System)^2 + (kVAR System)^2}}$	

Appendix E—Communication Options on the ELITEpro XC

In this section the available communication options and their setup steps are described in further detail, including USB, Ethernet (LAN), Wi-Fi, and *Bluetooth*.

Feature	USB	Ethernet	Bluetooth	Wi-Fi
16 MB Approximate Download Time	4 Min	12 Min	22 Min	40 Min
Range	Length of USB cable	Length of network cable	10-100ft	40-100ft
Access With...	PC + ELOG	PC + ELOG or Web browser	Bluetooth-enabled PC + ELOG	PC + ELOG or Web browser

USB (STANDARD)

A USB connection is the standard (and fastest) connection option for the ELITEpro XC, used locally for transferring data when a laptop is available in the field.



- 1) Connect the USB cable to a USB port on your computer, inserting the other end in the USB port on the ELITEpro XC. If a USB cable is used inside an electrical panel, it must be rated to the appropriate voltage or wrapped in an appropriately rated insulating sleeve. The DENT-supplied cable does not meet this requirement without an insulating sleeve.
- 2) ELOG should launch automatically and connect to the logger. If it does not, click on the icon on the computer desktop.

- The ELITEpro XC should automatically connect to the PC. If it does not, choose the correct location from the Friendly Ports™ drop-down menu.

ETHERNET LAN (STANDARD)

The Ethernet option is also used for a direct connection where a network is available. Ethernet connections must be configured initially via USB by users familiar with the network details and may require the assistance of a network administrator.

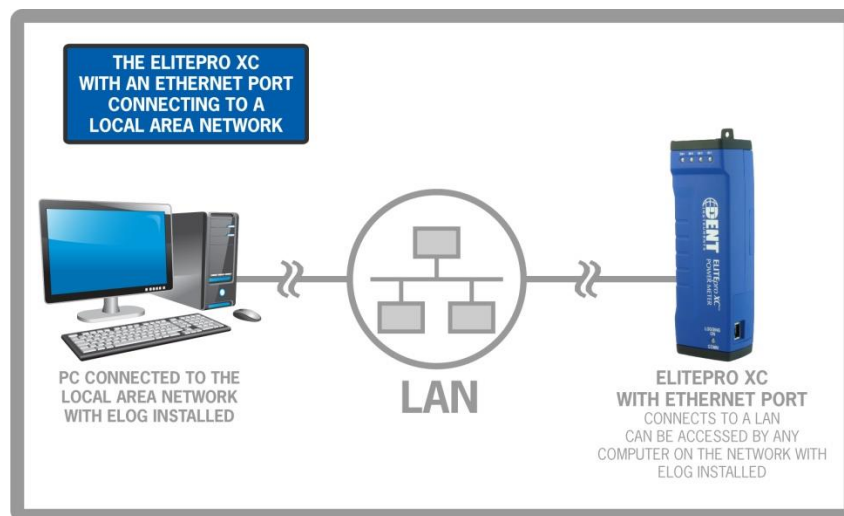

NOTE: Each ELITEpro XC connected to the network requires its own unique network IP Address. An address will be provided automatically if the network allows DHCP (Dynamic Host Configuration Protocol) and the ELITEpro XC is configured to request an address.



- Configure the EXC for use on the network. First connect the USB cable to a USB port on your computer, inserting the other end into the USB port on the ELITEpro XC. If a USB cable is used inside an electrical panel, it must be rated to the appropriate voltage or wrapped in an appropriately rated

insulating sleeve. The DENT-supplied cable does not meet this requirement without an insulating sleeve.

- 2) ELOG should launch automatically and connect to the logger. If it does not, click on the icon on the computer desktop.
- 3) The ELITEpro XC should automatically connect to the PC. If it does not, choose the correct location from the Friendly Ports™ drop-down menu.
- 4) Configure the Logger Ethernet Setup information once the ELITEpro XC has established a connection with the PC.
 - a) From the ELOG menu, select **Logger > Communication > Logger Ethernet Setup...** The Logger Ethernet Setup dialog box displays.

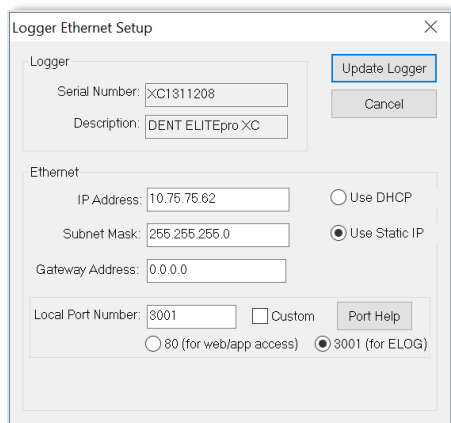

The Ethernet connection must have an IP Address that can either be set manually with the *Use Static IP* address option (for a fixed address) or obtained automatically from the router connected to the logger using the *Use DHCP* option (dynamic address). Both options have advantages.

- **Static Connection**

If you know an IP address that is not being used by another device on the network select the **Use Static IP** option and enter that address into the IP Address: field. This may require permission from a network administrator. With a static IP address, it is easy to connect to the logger with ELOG as there is no doubt about what IP address to use.

- **Dynamic Connection (DHCP)**

If you want the router to assign an IP address to the meter automatically, select **Use DHCP**. This may avoid the need of a network administrator as the router will assign an IP address that does not conflict with any other devices on the network. A disadvantage of the DHCP option is that the “lease” of the IP address may expire after a period of time and the router could assign a different IP

address. A new IP address means that ELOG cannot connect to the logger until the new IP address has been entered when using the Network Connect option. (See below.)

An additional option is to set the logger to DHCP and go to the router and assign a specific IP address to the MAC address that corresponds to the logger. In this way, if the lease does expire, the router will always assign the same IP address back to the logger. This option may also require the network administrator.

- b) If necessary, change the Port Number. The factory default is 3001 and will usually work in most cases.

The use of the Subnet Mask and Gateway Address are outside the scope of this manual. If needed, ask the network administrator for assistance

- c) Click **Update Logger**. The following message displays:

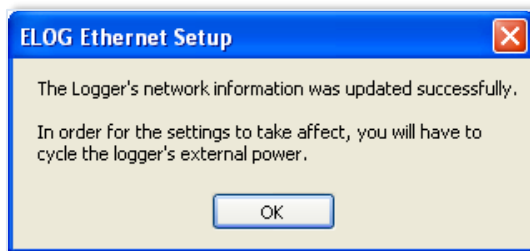

- d) Select **OK** then remove all power to the logger including the USB cable to perform a power cycle.
- e) **(Skip this step if Static IP was used.)** If DHCP was selected, reconnect the logger using the USB cable and use **Logger > Communication > Logger Ethernet Setup...** to determine what IP address was assigned by the network router to the logger. Note this IP address and disconnect from the USB connection.

- 5) Connect an Ethernet cable from the network into the Ethernet port on the side of the logger.

- 6) Click the **Ethernet or Wi-Fi Connection** speed button (📶) on the toolbar to reconnect via Ethernet. The Network Connect dialog box displays:

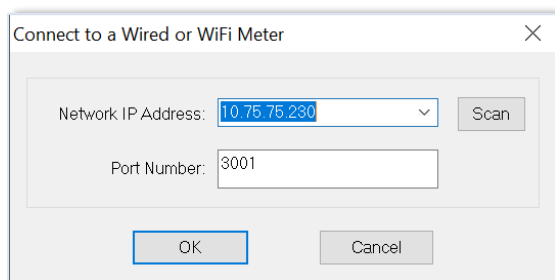

- 7) Enter the **Network IP Address** and **Port Number** if it is not automatically populated. Select **OK** to proceed and establish your Ethernet connection.

NOTE: If you do not know your *Network IP Address* or *Port Number*, click the **Scan** button on the Network Connect window. ELOG will scan the network for loggers and display them in the Logger Selection dialog box. Look for the serial number of the logger to determine which connection point is yours. The logger's serial number can also be found on the back of the logger. Select your logger in the Logger Selection dialog box and click **OK**, and then **OK** again in the Network Connect window.

WI-FI AND WIRELESS ACCESS POINT-TO-POINT CONNECTION (OPTIONAL)

The optional Wi-Fi module may be used in one of two ways: as a Wi-Fi connection to an existing Wi-Fi network or in Access Point-to-Point Mode where the logger connects directly to devices such as laptops or smart phones.

Connection ranges depend on whether an internal antenna or external, high-gain antenna is used.



The Wi-Fi connection will work over a range of 40 to 100ft, depending on the installation environment and antenna choice. Range is limited when mounted within a metal cabinet.

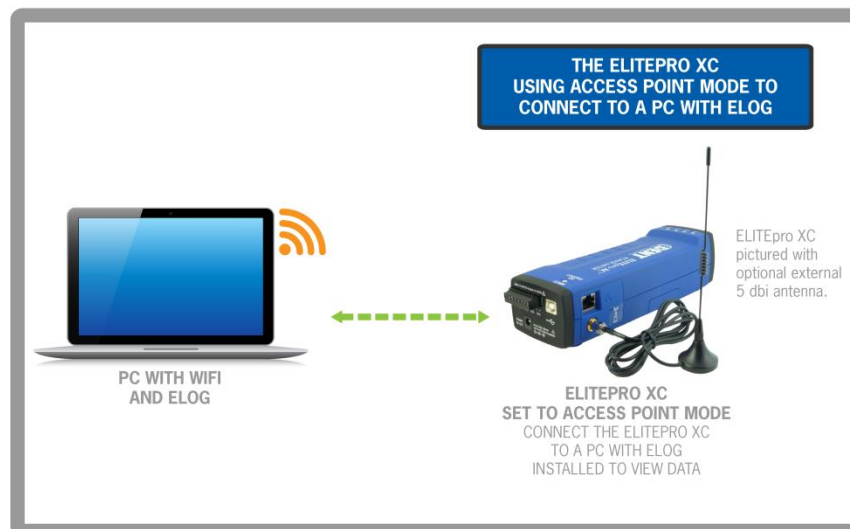

ELITEpro XC as its own Access Point

Using the ELITEpro XC as an access point or “hotspot” enables Wi-Fi connections where no existing wireless network is available, or where access to existing networks is not allowed.

- 1) Set up the logger for Access Point connection. Connect the USB cable to a USB port on your computer, inserting the other end in the USB port on the ELITEpro XC. If a USB cable is used inside an electrical panel, it must be rated to the appropriate voltage or wrapped in an appropriately rated insulating sleeve. The DENT-supplied cable does not meet this requirement without an insulating sleeve.
- 2) If it does not launch automatically, start ELOG and connect to the logger.
- 3) From the ELOG menu, select **Logger > Communication > Logger Wi-Fi Setup....** The Logger Wi-Fi Setup dialog box appears.

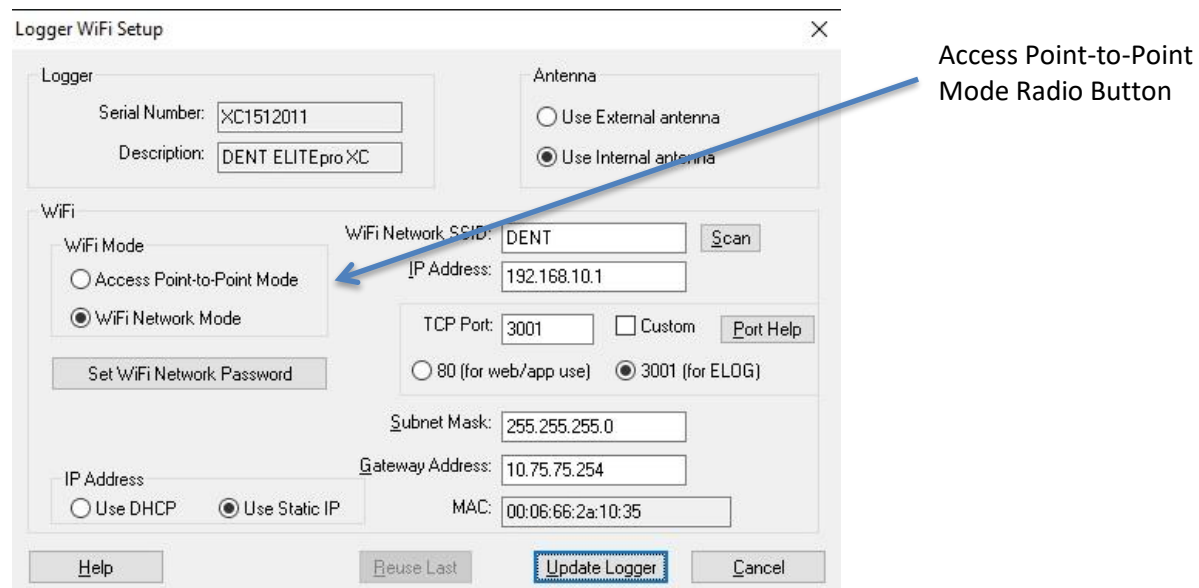

NOTE: All ELITEpro XC loggers equipped with a Wi-Fi module contain an *internal* antenna. An *external* antenna is optional. You may toggle between the internal and external antenna (if it is available on your logger) by selecting the appropriate radio button.

- 4) Select the **Access Point-to-Point Mode** radio button in the Wi-Fi Mode section of the dialog box.
- 5) Click **Set Logger Access Point Password**. The Set Logger Access Point Password dialog box displays. Enter a password (if desired) for use when connecting to the ELITEpro access point. If you want the access point open (no password required), leave the field blank. Click **OK**.

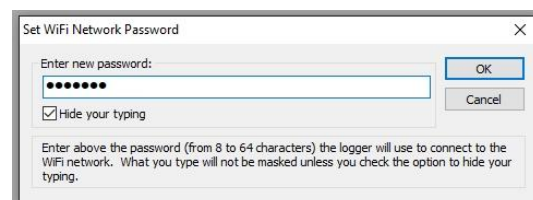

- 6) Select the TCP Port to use when connecting to the meter. Use port 80 or 3001.

- 7) Click **Update Logger** in the Logger Wi-Fi Setup dialog box.

ELOG updates the Wi-Fi settings and prompts you to click **OK** in order to reset the **ELITEpro XC**.

NOTE: After the blue COMM LED on the ELITEpro XC device stops blinking, use the ELOG command **Logger > Communication > About the Connected Logger** to verify that all entries in the Logger Properties dialog box match the values you entered.

When using Access Point-to-Point Mode, the SSID is based on the logger serial number and the IP address is 192.168.1.1.

- 8) Open a Network Connection dialog on your PC. (You may need to click **Refresh**.) Select the access point with the **SSID** (described above) and click **Connect**. Ensure that Windows connects to the access point.

NOTE: While acting as an Access Point, the ELITEpro XC allows multiple devices to connect (associate). However, only one device at a time may be communicating with the meter (using ELOG or the web browser). Additionally, these devices will NOT be networked together as they would if connected to a standard Wi-Fi access point because the ELITEpro provides no routing functions.

ELITEpro XC Connected to a Wireless Network

An ELITEpro XC with a Wi-Fi module may also be connected to a local area network (LAN) through a wireless access point or wireless router. To set up the logger it must first be configured via a USB connection to a PC running ELOG and may require assistance from someone familiar with the network you want to connect to. Below is a diagram of this communication method:

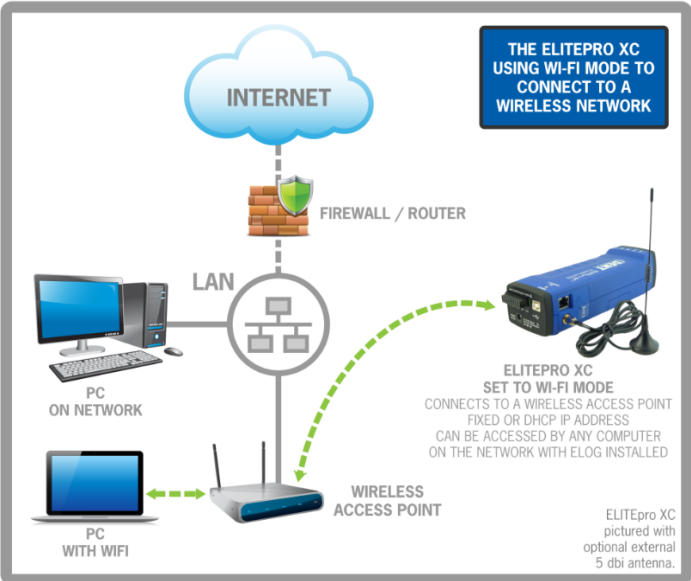

- 1) Set up a Wi-Fi logger for connection to a wireless network first. Connect the USB cable to a USB port on your computer, inserting the other end in the USB port on the ELITEpro XC. If a USB cable is used inside an electrical panel, it must be rated to the appropriate voltage or wrapped in an appropriately rated insulating sleeve. The DENT-supplied cable does not meet this requirement without an insulating sleeve.
- 2) If it does not launch automatically, start ELOG and connect to the logger.
- 3) From the ELOG menu, select **Logger > Communication > Logger Wi-Fi Setup....** The Logger Wi-Fi Setup dialog box appears.

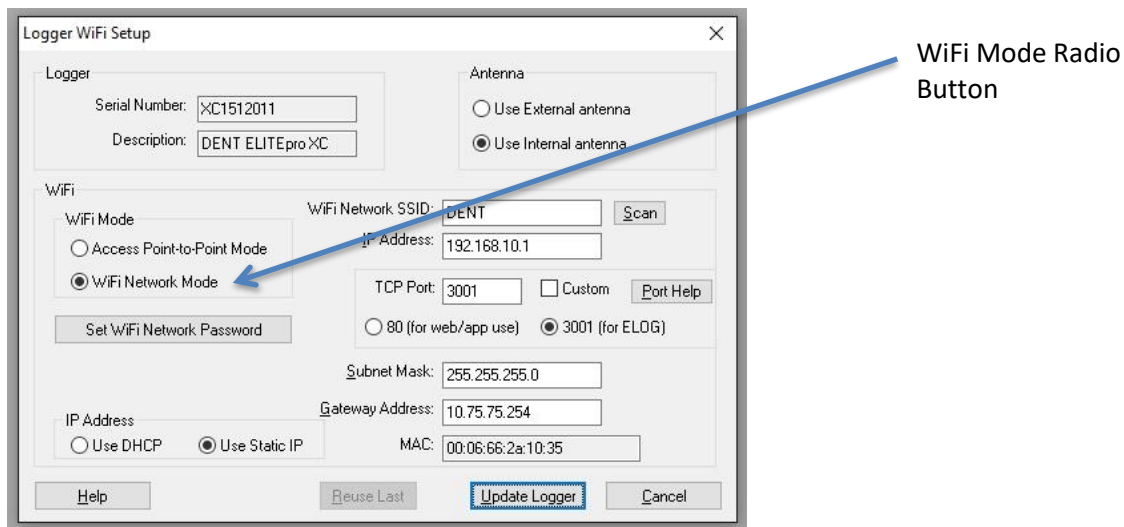

Note: All ELITEpro XC loggers that are equipped with a Wi-Fi package contain an *internal* antenna. An *external* antenna is optional. You may toggle between using the internal and external antenna (if it is available on your logger) by selecting the appropriate radio button.

- 4) Select the **Wi-Fi Mode** radio button in the Wi-Fi Mode section of the dialog box.

A network administrator may be needed for the next three steps.

- 5) Enter the name of the wireless network in the **Wi-Fi Network SSID** field.
- 6) Click **Set Wi-Fi Network Password** and enter the network's password in the dialog box.

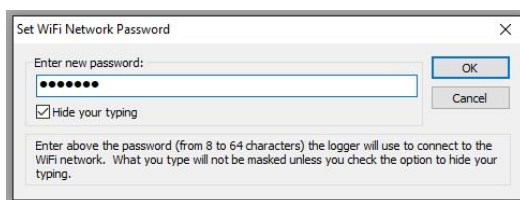

- 7) Click the **Use DHCP** radio button if your network uses DHCP to assign IP address information.

-or-

Click the **Use Static IP** radio button and enter the **IP Address**, **Subnet Mask**, and **Gateway Address** provided by the network administrator when your network uses static IP address assignments.

NOTE: To connect to the logger wirelessly you will need to know what IP address the router assigned to the logger. This can be found by making a direct, USB connection to the logger and then use **Logger > Communication > About the Connected Logger...** to see the IP address.

- 8) Select the **TCP port** to use when connecting to the meter. Use port 80 or 3001.
- 9) Click **Update Logger** in the Logger Wi-Fi Setup dialog box.



ELOG updates the Wi-Fi settings and prompts you to click **OK** in order to reset the ELITEpro XC.

NOTE: After the blue COMM LED on the ELITEpro XC stops blinking, use the ELOG command **Logger > Communication > About the Connected Logger** to verify that all entries in the Logger Properties dialog box match the values you entered.

The logger can now be connected to the LAN via a Wi-Fi link to the wireless router on the network.

Accessing the ELITEpro

There are three ways to access the **ELITEpro XC via Wi-Fi** once you are connected:

- **Using ELOG to connect to the ELITEpro XC access point**
 - a) Disconnect from the USB connection using **Logger > Connection > Terminate Connection** or by using the **Disconnect** speed button ().
 - b) Click the **Ethernet or Wi-Fi Connection** speed button () on the toolbar.
 - c) In the **Network Connect** dialog box, enter the **IP Address**, the **Port Number** entered during setup, and click **OK**.

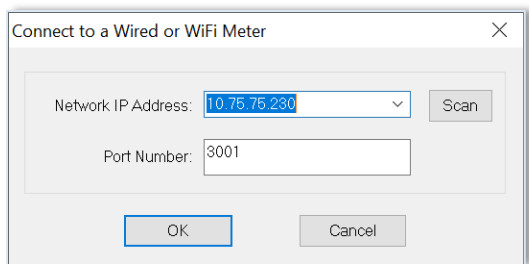

You may now use all the capabilities of ELOG with the logger.

- **Using a Web Browser to connect to the ELITEpro XC Built-in Web Server**

The ELITEpro XC includes a basic internal web server that allows external devices such as smart phones, tablets, PCs, etc., to connect to the logger and replicate a limited set of ELOG functions, i.e., viewing Real-Time Values or reading data. An additional password is required to access the server.

- Select **Logger > Communication > Logger Web Login Password**. The Web Login Password dialog box displays.

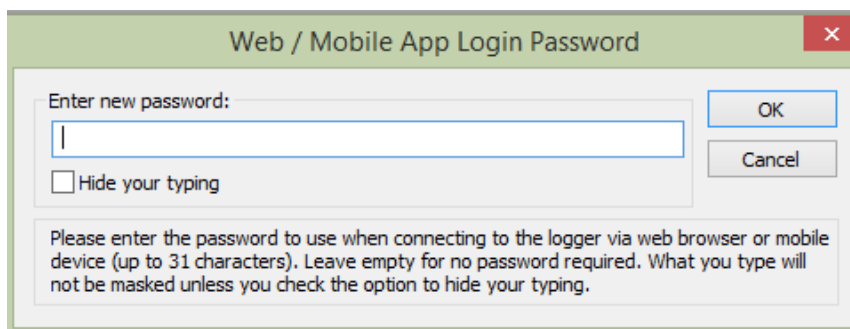

- Open a web browser on the device that will communicate with the ELITEpro.
- In the Address box of the browser, enter the IP Address of the ELITEpro XC as previously configured. For example: <http://192.168.1.1>.

NOTE: If you selected a port other than port 80, add a colon followed by the port number to the end of the IP Address, for example: <http://192.168.1.1:3001>.

- When the login page appears, enter the **Web Login Password** you set in the dialog box in Step A above. (The default password is 1234.) Please note that this is the distinct password used to connect to the wireless access point.

You can view real-time values, view or download logged data as an Excel CSV file, start/stop logging, clear the logger memory, and view the logger properties. Other ELOG functions such as creating or changing a Setup Table are not available. The Web Server interface is convenient for verifying a meter is correctly connected by viewing real-time values without needing a PC or laptop.

Troubleshooting Wi-Fi Connections

If you are unable to connect to the logger, check the following items:

- 1) Connect to the logger using a USB connection. From within ELOG, view the logger properties under **Logger > Communication > About the Connected Logger**.
- 2) Check the signal strength indicator (in percent or dBm) to ensure you have a good signal.
- 3) Ensure the Wi-Fi section has the proper settings (i.e. correct addresses). Ensure the Wi-Fi module is active, which can be determined by the “No TCP connection” message. Ensure the blue COMM LED is not blinking.
- 4) If you are unable to make a connection, contact DENT Instruments for questions and assistance.

BLUETOOTH (OPTIONAL)

Bluetooth is intended for wireless connections up to 100ft, depending on the installation environment. The ELITEpro XC uses the higher power Class 1 *Bluetooth* transceiver for longest range. Please note that range may be limited if the ELITEpro XC is mounted within a metal cabinet.

NOTE: A laptop cannot be in a docking station when using *Bluetooth*.



Connections must be configured initially via USB by users with knowledge of Windows *Bluetooth* enabled products.

To make a *Bluetooth* connection from a PC to an ELITEpro XC both devices must have a Bluetooth module. If your PC or laptop does not have *Bluetooth*, it will be necessary to purchase a *Bluetooth* dongle (usually a plug-in USB device) and add it to the PC. If purchasing an external *Bluetooth* dongle ensure that it supports SPP, Serial Port Protocol. Typically, the packaging will indicate if it supports SPP. Follow the *Bluetooth* manufacturer's instructions for installing the Bluetooth device.

The rest of this discussion assumes that the PC has *Bluetooth* capability. *Bluetooth* devices must be "paired" to communicate. Additional information may be found by searching for "Bluetooth" in the Search box in Windows 10. Look for "Bluetooth & Other Devices." Click the "Add Bluetooth or other device" from this screen. Or, look in the Task Bar on your PC for the Bluetooth icon (). After clicking the *Bluetooth* icon a window should open as shown below:

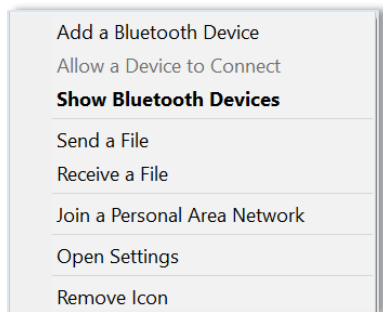

- 1) Click **Add a Device**. You should then see a list of *Bluetooth* devices external to the PC including the ELITEpro XC identified by its serial number.
- 2) Select the desired ELITEpro XC and click **Next**.
- 3) The next screen shows you a pairing code. When asked whether the code matches your device, click **Yes**. Windows will then connect to the device and provide a serial port for communication.
- 4) Next determine which com port Windows assigned to the *Bluetooth* link. In ELOG, click on the **PC Setup** speed button. Windows may have assigned two COM ports to the *Bluetooth* link but only one will work for communication. The correct port to use is found through trial and error.

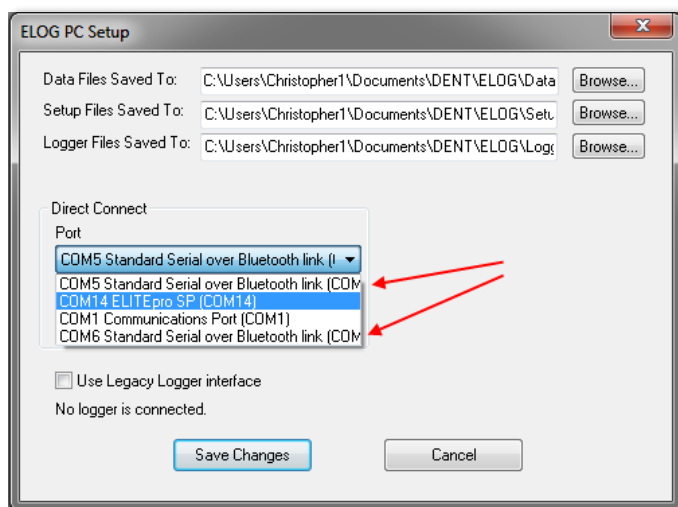

- 5) Click on the first "...Standard Serial over Bluetooth link..." found in the Direct Connect Port drop-down list, click **Save Changes**, and attempt to communicate using Direct Serial or Bluetooth Connection speed button or use **Logger > Communication > Connect via USB or Bluetooth**. The connection may take up to 10 seconds to complete.

If the first port attempted fails, try again using the other *Bluetooth* port found in PC Setup. Repeat, if necessary, until a connection is established and the correct *Bluetooth* port is known.

- 6) Reopen ELOG PC Setup and click the **Port Preferences** button. The COM Port Preferences dialog box displays where you can deselect the check boxes for the ports that are not used by ELOG, including the extra COM port(s) for the *Bluetooth* connections, by clicking on an unneeded checkbox to remove the check.

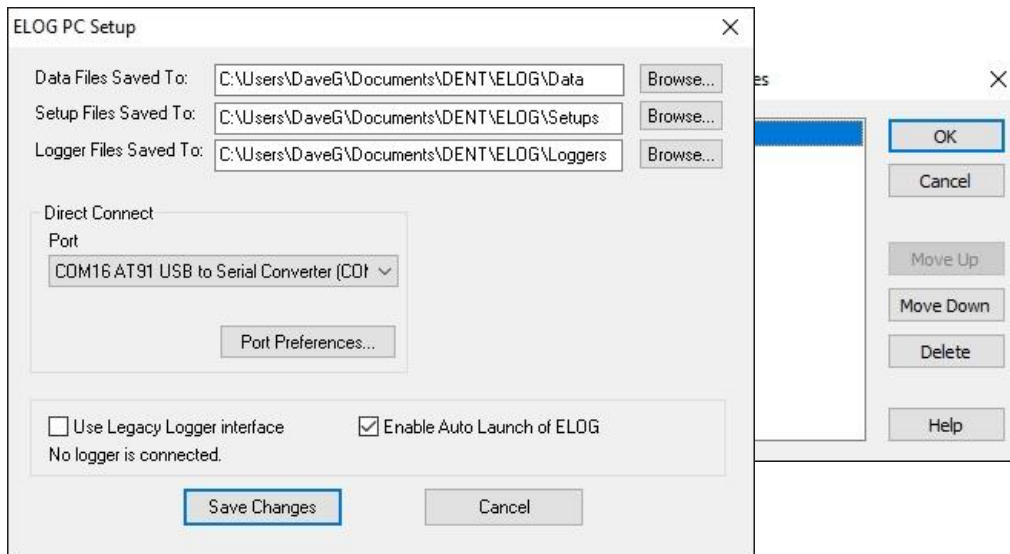

- 7) Click **OK**, and then **Save Changes** in the ELOG PC Setup dialog box. The unused COM Ports no longer appear in the Port drop-down list.

If you are unable to connect to the logger, check the following items:

- 1) In Windows Control Panel, open Devices and Printers and verify that the ELITEpro XC is shown in the Bluetooth devices along with the Bluetooth module in the PC. If not, reinstall the PC's Bluetooth device and/or re-pair the PC to the logger.
- 2) If the logger does not appear after repeating the steps, ensure that the device is powered and the blue COMM light is flashing.
- 3) If the logger is visible and you are unable to make a connection, or if you are unable to get the device added via the Windows Control Panel, contact DENT Instruments for troubleshooting assistance (support@dentinstruments.com).

Appendix F—Meter Installation Final Checklist

The following is a checklist to cover the majority of what needs to be considered when installing a DENT Instruments power meter. It is not intended to be all-encompassing as every scenario will be different.

Put an X in the check box when the checklist item has been addressed and add a comment where required.

Checklist Item	Pass	N/A	Comment
Pictures: Outside of electrical room to aid in locating electrical panel for next visit, inside electrical room, picture of meter installed along with CT installation and Voltage connection	<input type="checkbox"/>	<input type="checkbox"/>	
Using ELOG, verify the logger setup is correct			
Is the data Interval set (typical is 15 minutes)?	<input type="checkbox"/>	<input type="checkbox"/>	
Does Vhigh and Vlow match the voltage phases the CTs are installed on?	<input type="checkbox"/>	<input type="checkbox"/>	
Does the CT Type setting match the CT used?	<input type="checkbox"/>	<input type="checkbox"/>	
Does the CT Amp setting match the CT used?	<input type="checkbox"/>	<input type="checkbox"/>	
Does the CT Phase Shift match the table at bottom of check list for the CT used (also included in the manual)?	<input type="checkbox"/>	<input type="checkbox"/>	
Are the Recorded Values selected as needed for the project?	<input type="checkbox"/>	<input type="checkbox"/>	
Is the logger's time correct?	<input type="checkbox"/>	<input type="checkbox"/>	
Is the Logging On LED flashing green?	<input type="checkbox"/>	<input type="checkbox"/>	

Verify measurements are correct	Pass	N/A	Comment
Are the PhaseChek LEDs green?	<input type="checkbox"/>	<input type="checkbox"/>	
Are the currents and watt measurements reasonable for the load (helps to verify the correct load is monitored)?	<input type="checkbox"/>	<input type="checkbox"/>	
Are the phase currents relativity close to each other (within about 20%) on a load that should be balanced?	<input type="checkbox"/>	<input type="checkbox"/>	
For WYE loads, are the phase watts relativity close to each other (within about 20%)?	<input type="checkbox"/>	<input type="checkbox"/>	
For WYE loads, are all the phase watts positive?	<input type="checkbox"/>	<input type="checkbox"/>	
For WYE loads, are the phase PF readings relativity close to each other when monitoring a balanced load?	<input type="checkbox"/>	<input type="checkbox"/>	
If available, compare to external references (within a percent or two, no two meters will read exactly the same).	<input type="checkbox"/>	<input type="checkbox"/>	
Digital Voltmeters (DVM): Does the meter phase voltages match the DVM's?	<input type="checkbox"/>	<input type="checkbox"/>	
Clamp-on Amp meters (e.g., Amprobe): Do the meter phase currents match the clamp-on Amp meter?	<input type="checkbox"/>	<input type="checkbox"/>	
Clamp-on Power Meters (e.g., Fluke 41): Do the meter phase watts match the clamp-on Power Meter?	<input type="checkbox"/>	<input type="checkbox"/>	

Communications with Meter	Pass	N/A	Comment
If using remote communication, can the meter be communicated with (Wi-Fi, Bluetooth)?	<input type="checkbox"/>	<input type="checkbox"/>	
Final			
Are all cabinet doors, closed, locked, and all screws in panels tightened?	<input type="checkbox"/>	<input type="checkbox"/>	
Is all trash picked up, leaving site as clean as it was when arrived?	<input type="checkbox"/>	<input type="checkbox"/>	

Appendix G – ELITEpro XC Technical Specifications

Specification	Description
Memory	16 MB non-volatile
Service Types	Single Phase-Two Wire, Single Phase-Three Wire, Three Phase-Four Wire (WYE), Three Phase-Three Wire (DELTA), DC Systems (solar/battery).
Voltage Channels	3 channels, CAT III, 0-600 VAC (line-to-line) or 600 VDC
Current Channels	4 channels, .67 VAC max, +/- 1 VDC max; ideal for 333 mV full scale CTs
Maximum Current Channel Input Voltage	External transducer dependent; 200% of current transducer rating (mV CTs); Measure up to 6000A with RōCoil CTs
Measurement Type	True RMS using high-speed digital signal processing (DSP)
Line Frequency	DC/50/60Hz
Waveform Sampling	12 kHz 200 samples/cycle at 60Hz 240 samples/cycle at 50Hz
Channel Sampling Rate (internal sampling)	8 Hz or every 125 mSec.
Data Interval	The default integration period is fifteen minutes. The choices are 1, 3, 10, 15, 30 seconds; 1, 2, 5, 10, 15, 20 and 30 minutes; 1 and 12 hours; 1 day.
Energy Measurements	Volts, Amps, Amp-Hrs (Ah), kW, kWh, kVAR, kVARh, kVA, kVAh, Displacement Power Factor (dPF). All parameters for each phase and for system total.
Analog Measurements	0–10 Volts, 0 or 4–20 ma current loop non-isolated, external power for current loop. User scaling for sensor reporting in physical units.
Accuracy	Better than 1% (<0.2% typical) for V, A, kW, kVAR, kVA, PF
Resolution	0.01 Amp, 0.1 Volt, 1 Watt, 1 VAR, 1 VA, 0.01 Power Factor, 0.001 ANALOG
LED Indicators	Tri-colors (red, green, and blue): 1 LED to indicate communication, 4 LEDs for correct phasing (green when voltage and current on the same phase; red when incorrectly wired, blue for wireless, <i>Bluetooth</i> wireless technology, and Ethernet).
Communication	
USB (Standard)	USB (Type B). 1.8 M (6 FT) A-to-B USB Cable (included)
ETHERNET (Standard)	Standard RJ-45 Connector supports 10/100 MB Ethernet over Cat 5 or better. Configure for DHCP or Static IP address.
<i>BLUETOOTH</i> ® Wireless Technology (Optional)	Internal antenna: typical conditions <10ft up to 100ft range. Requires <i>Bluetooth</i> adapter on Window PC. Adapter must support the Serial Port Profile (SPP).

Specification	Description
Wi-Fi Adapter (Optional)	<p>Internal Wi-Fi adapter with two separate configurations: Internal antenna/External 5 dbi antenna: typical conditions <40ft up to 100ft depending on environment and antenna.</p> <p>The wireless module supports WEP-128, WPA-PSK (TKIP), or WPA2-PSK (AES)</p>

Power	
Line Power Supply	<p>From L1 Phase to L2 Phase. 80-600V (AC or DC) CAT III DC/50/60Hz, 125 mA, 5 W, or 10 VA max.</p> <p>Non-user replaceable .5 Amp internal fuse protection.</p>
Power In (optional)	6-10 VDC maximum, 500 mA minimum
Mechanical	
Operating Temperature	-7 to + 60°C (20 to 140°F)
Humidity	5% to 95% non-condensing
Enclosure	ABS plastic, 94-V0 flammability rating
Weight	340 g (12 ounces, excluding sensors and leads)
Dimensions	69 x 58 x 203 mm (2.7" x 2.2" x 8.0")
Minimum System Requirements	
Operating System	Windows® 7 (32 or 64 bit), Windows® 8, Windows® 10
Processor	Pentium Class 1 GHz or more recommended
Hard Drive	50 MB minimum available
Communications Port	One USB port required for logger connection and ELOG software installation

Analog Input Technical Specifications	
MAXIMUM INPUT VOLTAGE	30 VDC, Unipolar Measurements Only.
MAXIMUM INPUT CURRENT	<p>23 mA</p> <p>Note: the current limit will be exceeded before 30 volts of applied potential when selected for current mode or connected with reverse polarity.</p>
A/D	16 bit
INPUT IMPEDANCE	50.0 K (voltage mode), 499 ohm (current mode)
SAMPLING FREQUENCY	4 HZ - per channel, 16 HZ total throughput
ACCURACY	<0.2% typical

Appendix H – DENT Instruments Warranty Statement

Rev 4/9/2015

DENT Instruments, Inc. promises buyer that any product sold by DENT Instruments, Inc. shall be free from material defects in design, materials, or manufacturing for the period shown on the current datasheet for that product beginning from the manufacture date; provided, however, that the warranty shall not extend to ordinary wear and tear, or to normally replaceable components (e.g., batteries and humidity sensor elements). During the warranty period, DENT Instruments, Inc. may repair or replace (at its sole discretion) any product suffering from a warranty defect and returned freight prepaid by buyer, with no charge to buyer for any warranty repair or replacement. The warranty shall remain in full force and effect for said period, provided that the product: (1) was installed, operated, and maintained properly; (2) has not been abused or misused; (3) has not been repaired, altered, or modified outside of DENT Instruments' authorized facilities; (4) has not been sold subject to other warranty terms specified at the time of sale. This warranty provides specific legal rights that may be varied by local laws.

ELITEpro Series and Accessories

Seller warrants to Buyer that ELITEpro Series products and accessories or services are free from substantial defect in material and workmanship under normal use given prior installation and maintenance for the period of 1 year (12 months) after delivery

LIMITATION OF WARRANTY

CORRECTION OF DEFECTS BY REPAIR, REPLACEMENT, SERVICE OR CREDIT WILL BE AT SELLER'S OPTION AND CONSTITUTE FULFILLMENT OF ALL OBLIGATIONS TO BUYER FOR BREACH OF WARRANTY.

Seller assumes no warranty liability with respect to defects in the product caused by: (a) modification, repair, installation, operation or maintenance of the product by anyone other than Seller or its agent, except as described in Seller's documentation; or (b) the negligent or other improper use of the product.

Other manufacturers' equipment purchased by Seller and resold to Buyer will be limited to that manufacturers' warranty. Seller assumes no warranty liability for other manufacturers' equipment furnished by Buyer.

No agent, distributor, or representative is authorized to make any warranties on behalf of Seller or to assume for Seller any other liability in connection with any Seller product or service.

DISCLAIMER OF WARRANTY

Buyer understands and agrees as follows:

THE ABOVE WARRANTY REPLACES ALL OTHER WARRANTIES, EXPRESSED OR IMPLIED, & ALL OTHER OBLIGATIONS OR LIABILITIES OF SELLER, INCLUDING ANY WARRANTIES OF MERCHANTABILITY AND FITNESS FOR A PARTICULAR PURPOSE. ALL OTHER WARRANTIES ARE DISCLAIMED AND EXCLUDED BY SELLER. THE FOREGOING WILL BE THE SOLE AND EXCLUSIVE REMEDY WHETHER IN CONTRACT, TORT, OR OTHERWISE, & SELLER WILL NOT BE LIABLE FOR INJURIES OR DAMAGES CAUSED BY THE GROSS NEGLIGENCE OF SELLER. THIS LIMITATION APPLIES TO ALL SERVICES AND PRODUCTS DURING AND AFTER THE WARRANTY PERIOD.

LIMITATION OF REMEDIES

IN NO EVENT WILL SELLER BE LIABLE FOR ANY SPECIAL, INCIDENTAL OR CONSEQUENTIAL DAMAGES OR COMMERCIAL LOSSES EVEN IF SELLER HAS BEEN ADVISED OF THE POSSIBILITY THEREOF.

GENERAL PROVISIONS

- A. Seller reserves the right to subcontract any obligation hereunder.
- B. No waiver will be valid unless in writing and no waiver granted will release Buyer from subsequent strict compliance herewith.
- C. Seller is not liable for failure or delay in fulfilling its obligations under these Terms and Conditions due to causes beyond its reasonable control.
- D. The laws of the State of Oregon, U.S.A. will apply to all transactions hereunder. Any action hereunder will be brought in Deschutes County, in the State of Oregon, U.S.A. Any claim, except for nonpayment, will be brought within one year of product shipment or completion of services and Buyer will be liable for any collection costs or attorney fees.
- E. Claims for non-conforming orders must be submitted within 30 days from shipment date.
- F. These Terms & Conditions together with Seller's Order Acknowledgment constitute the entire agreement between the parties with respect to the subject matter hereof & supersede any prior or contemporaneous agreement or representation written or oral. Any amendment hereto must be written and signed by Seller.

Service and Support for DENT Instruments Products

Before calling, remember that many questions are answered in the Operator's Guide for your product. Furthermore, there is extensive product information on the website. In the event that you have a problem with your DENT product that you cannot resolve, please note the following information. **Before contacting DENT Tech Support, note the Model Name and Serial Number for your product. You should also be prepared to list the hardware and software details of your PC and related equipment.**

CONTACT DENT INSTRUMENTS TECHNICAL SUPPORT
541.388.4774 or 800.388.0770
support@dentinstruments.com
www.dentinstruments.com

INDEX

A

Analog Connections	23
appending new data	69
AutoPoll	16, 68

B

Bluetooth	30, 65
detailed connection information	116

C

Calculated Power Channel	
calculations	102
combining channels	45
Calculated Power Channels	41, 45
calculating CT value	53
cancel communications operation	66
Communication Sub-Menu	64
About the Connected Logger	68
AutoPoll	68
Cancel Communications Operation	65
Choose From Last Used Logger List.....	65
Connect via Ethernet or WiFi	65
Connect via USB or Bluetooth.....	65
Logger Ethernet Setup	65
PC Setup	65
Terminate Connection	65
configuring a power channel	41
creating a CSV file	70
CT	
selection list	42
CT Connection	
polarity.....	53
CT Connections	19, See also CTs
millivolt	20
polarity.....	21, 41
UL listings.....	51

CTs

calculating the value.....	53
connecting	53
current ratings.....	52
Phase Shift Values	40
selecting	51
selection of	53
UL recognized.....	52
Current Transformer	See CTs

D

data	
appending.....	69
data range	90
exporting	86
extract by date or record number	91
Data File Summary	
report example.....	89
data interval	37
data logging	38
Data Logging	
start options	38
stop options.....	38
Data Menu	82
Analyze a Selected Data Range.....	90
Check Data for Errors	92
Create New Graph	82
Data File Summary	87
Export Data File	86
Extract a Range of Data	91
Fill Missing Records	92
Graph Options	85
Import CSV File	87
Open Data File	86
Retrieve Data From Logger.....	86
Data summary	87
DELTA configuration	103
Digital Channel	
maximum output rate	28
pulse output	28
scale.....	28
value	28
Digital Connections	27
Display Real Time Values Sub-Menu	

Harmonics	74
Show as Graphs.....	72
Show as Text	71
Waveform Capture	74

E

ELITEpro XC	<i>See</i> Logger
communicating with	31
Configure using the ELOG Logger Menu	64
configuring	80
connections.....	18
firmware	93
mounting.....	17
ELITEpro XC Connections.....	15
Bluetooth	30
digital	23
ethernet	30
power in/out.....	27
USB.....	27
voltage	23
WiFi.....	30
ELOG	
connection window.....	63
Data menu	82
Edit menu.....	63
File menu	61
firmware updates.....	93, <i>See also</i> Firmware
Installing the software	16
Logger menu	64
memory capacity	38
overview of the software screen	59
PC Setup.....	31
quick setups	39
Setup window	80
speed buttons	59
status bar	63
toolbar	63
Tools menu	80
View menu	63
window	59
ELOG Data File	61
Enable THD.....	40
Ethernet.....	30, 66
detailed connection information	105
Export data file.....	62
exporting data to spreadsheet	86
extracting a range of data.....	91

F

Firmware.....	81
downloading, installing updates.....	93
Friendly ports	31

G

Graph File.....	61
graphs.....	72, 82
analysis values	85
annotation.....	85
attributes.....	85
creating.....	83
data cursor	85
data options	85
data points.....	85
export	74
export formats.....	74
options	83
parameters	83
record range	83

H

Harmonics.....	75
recording values to your PC.....	75

I

Import CSV file	62
Installing ELOG software	16

L

last used logger list	66
LED Diagnostics	48
Communication	48
PhaseChek	48
Legacy Logger	32
Logger	
about the connected logger	68
configuring a Setup Table	37
creating a setup table.....	34
data logging	38
existing setup table	35

retrieving a setup table36
 saving a setup table48
 sending a setup table to logger.....47
Logger Clock Sub-Menu
 Manually Set Logger Time.....77
 Synchronize Time To Match PC.....77
logger connection window32
logger list
 last used66
Logger List File61
Logger Menu64
 Clear Logger option 79, *See also* Clear Logger Sub-Menu
 Communication option *See also* Communication Sub-Menu
 Display Real Time Values option *See also* Display Real Time Values Sub-Menu
 Logger Clock option *See also* Logger Clock Sub-Menu
Logger summary87

M

memory
 maximizing45
memory capacity.....38
Menus
 Data.....82
 Edit63
 File.....61
 Logger64
 Tools.....80
 View63
messages
 connecting with ESP.....32
metering systems, unusual94
Millivolt CTs20
Mounting the ESP.....17
 maximum weight17
 removal17

P

PC Setup..... 31, 65, 80
Phase Shift Values, recommended40
PhaseChek.....48
Physical Power Channel
 options43
polarity 21, 41, 53

Port preferences31
 friendly ports 31
Power Channel28
 Calculated45
 calculating formulas 102
 combining.....45
 configuring41
 configuring for power measurement 50
 delta configuration calculations 103
 Digital28
 Physical.....43
 wye configuration calculations..... 102
Power In/Out27
Power Measurement
 connecting sensors 50
 CT selection 51
 CT selection examples53
 preventing shock hazard 8, 50
 wiring conventions 51
PT Ratio.....41
Pulse Output28

Q

Quick Setups..... 39, 55
 wiring diagrams 55

R

Recorded Values.....42
retrieving data86

S

safety information..... 8
Sensor Data Plates24
Setup summary87
Setup Table
 configuring 37
 creating.....34
 existing35
 maximizing memory 45
 retrieving36
 saving.....48
 sending to logger47
Setup Table File62
Software installation16
spreadsheets86

Summaries

data, setup, logger	87
symbols on the ELITEpro XC	8

T

terminate connection	66
THD	40
Tools Menu	80
PC Setup	31, 80
Restore Hidden Messages	81
Update Logger Firmware	81
Total harmonic distortion	40
troubleshooting	
communications	32
troubleshooting ESP driver installation	99

U

UL Listings	51
update driver	99
update firmware	81
USB	27, 65
detailed connection information	104

V

voltage connections	23
voltage rating	23

W

Waveform capture	74
Web server	114
WiFi	30, 66
detailed connection information	108
troubleshooting connections	115
Wiring Connections	
CTs	19
Wiring Conventions	51
Wiring Diagram	
3-Phase, 3-Wire Delta	57
3-Phase, 4-Wire Wye	58
Single Phase, 2-Wire	55
Single Phase, 3-Wire	56
Wiring Diagrams	
quick setups	55